

# JVC

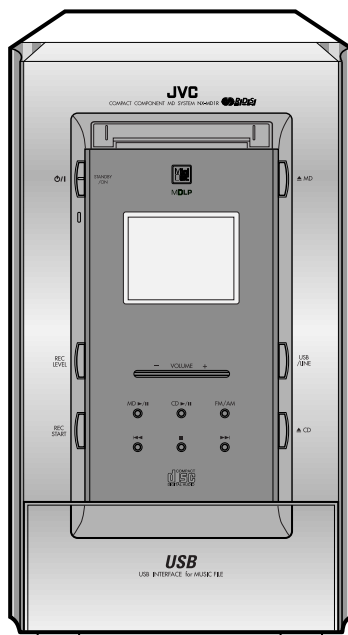

## COMPACT COMPONENT MD SYSTEM

# CA-NXMD1R

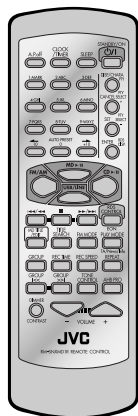

# MDLP



COMPACT  
**disc**  
DIGITAL AUDIO

## INSTRUCTIONS

### For Customer Use:

Enter below the Model No. and Serial No. which are located either on the rear, bottom or side of the cabinet. Retain this information for future reference.

Model No. \_\_\_\_\_

Serial No. \_\_\_\_\_

LVT0776-003A  
[B]

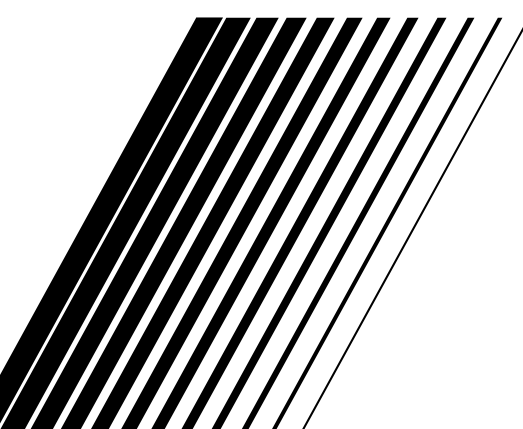

## Warnings, Cautions and Others

---

### **IMPORTANT for the U.K.**

**DO NOT** cut off the mains plug from this equipment. If the plug fitted is not suitable for the power points in your home or the cable is too short to reach a power point, then obtain an appropriate safety approved extension lead or consult your dealer.

**BE SURE** to replace the fuse only with an identical approved type, as originally fitted.

If nonetheless the mains plug is cut off ensure to remove the fuse and dispose of the plug immediately, to avoid a possible shock hazard by inadvertent connection to the mains supply.

If this product is not supplied fitted with a mains plug then follow the instructions given below:

### **IMPORTANT:**

**DO NOT** make any connection to the terminal which is marked with the letter E or by the safety earth symbol or coloured green or green-and-yellow.

The wires in the mains lead on this product are coloured in accordance with the following code:

Blue : Neutral  
Brown : Live

As these colours may not correspond with the coloured markings identifying the terminals in your plug proceed as follows:

The wire which is coloured blue must be connected to the terminal which is marked with the letter N or coloured black.

The wire which is coloured brown must be connected to the terminal which is marked with the letter L or coloured red.

**IF IN DOUBT - CONSULT A COMPETENT ELECTRICIAN.**

### **Caution — STANDBY/ON button!**

Disconnect the mains plug to shut the power off completely (the STANDBY/ON lamp goes off). The STANDBY/ON  button in any position does not disconnect the mains line.

- When the unit is on standby, the STANDBY/ON lamp lights red.
- When the unit is turned on, the STANDBY/ON lamp lights green.

The power can be remote controlled.

---

## IMPORTANT FOR LASER PRODUCTS

---

### REPRODUCTION OF LABELS

- ① CLASSIFICATION LABEL, PLACED ON REAR ENCLOSURE

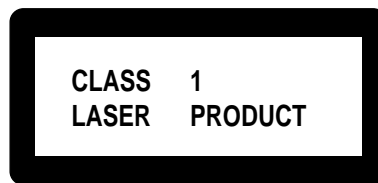

- ② WARNING LABEL, PLACED INSIDE THE UNIT

<b>CAUTION</b> : Invisible laser radiation when open and interlock failed or defeated. AVOID DIRECT EXPOSURE TO BEAM. (e)	<b>WARNING</b> : Osynlig laserstrålning när denna del är öppnad och spärren är urkopplad. Betrakta ej strålen. (s)
<b>ADVARSEL</b> : Usynlig laserstrålning ved åbning, når sikkerhedsafbrydere er ude af funktion. Undgåudsætelse for stråling. (d)	<b>VARO</b> : Avattaessa ja suojalukitus ohitettaessa olet alttiina näkymättömälle lasersäteilylle. Älä katso säteeseen. (f)

- 
1. CLASS 1 LASER PRODUCT
  2. **CAUTION**: Invisible laser radiation when open and interlock failed or defeated. Avoid direct exposure to beam.
  3. **CAUTION**: Do not open the top cover. There are no user serviceable parts inside the Unit; leave all servicing to qualified service personnel.
-

### CAUTION

To reduce the risk of electrical shocks, fire, etc.:

1. Do not remove screws, covers or cabinet.
2. Do not expose this appliance to rain or moisture.

### CAUTION

- Do not block the ventilation openings or holes.  
(If the ventilation openings or holes are blocked by a newspaper or cloth, etc., the heat may not be able to get out.)
- Do not place any naked flame sources, such as lighted candles, on the apparatus.
- When discarding batteries, environmental problems must be considered and local rules or laws governing the disposal of these batteries must be followed strictly.
- Do not use this apparatus in a bathroom or places with water. Also do not place any containers filled with water or liquids (such as cosmetics or medicines, flower vases, potted plants, cups, etc.) on top of this apparatus.

### Caution: Proper Ventilation

To avoid risk of electric shock and fire, and to prevent damage, locate the apparatus as follows:

- 1 Front : No obstructions and open spacing.
- 2 Sides/ Top/ Back : No obstructions should be placed in the areas shown by the dimensions below.
- 3 Bottom : Place on the level surface. Maintain an adequate air path for ventilation by placing on a stand with a height of 10 cm or more.

Front view

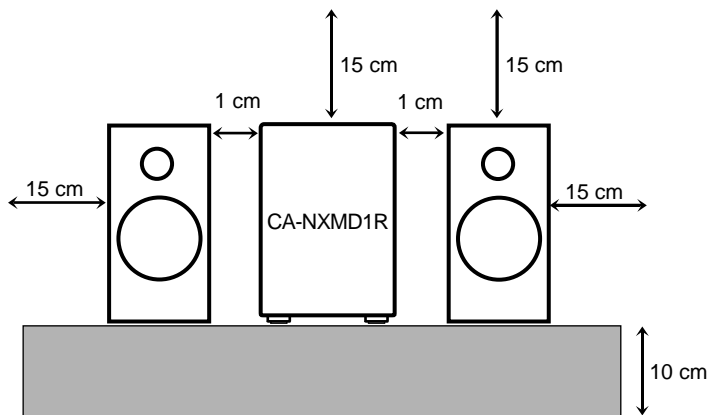

Side view

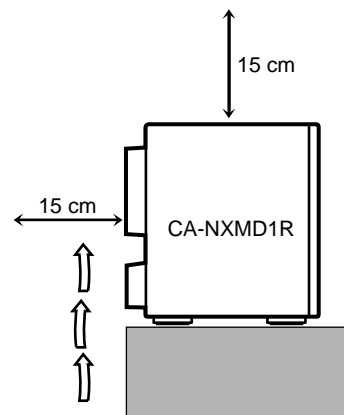

# SAFETY INSTRUCTIONS

## “SOME DOS AND DON'TS ON THE SAFE USE OF EQUIPMENT”

\*\*\*\*\*

This equipment has been designed and manufactured to meet international safety standards but, like any electrical equipment, care must be taken if you are to obtain the best results and safety is to be assured.

Do read the operating instructions before you attempt to use the equipment.

Do ensure that all electrical connections (including the mains plug, extension leads and interconnections between pieces of equipment) are properly made and in accordance with the manufacturer's instructions. Switch off and withdraw the mains plug when making or changing connections.

Do consult your dealer if you are ever in doubt about the installation, operation or safety of your equipment.

Do be careful with glass panels or doors on equipment.

\*\*\*\*\*

DON'T continue to operate the equipment if you are in any doubt about it working normally, or if it is damaged in any way – switch off, withdraw the mains plug and consult your dealer.

DON'T remove any fixed cover as this may expose dangerous voltages.

DON'T leave equipment switched on when it is unattended unless it is specifically stated that it is designed for unattended operation or has a standby mode.

Switch off using the switch on the equipment and make sure that your family know how to do this.

Special arrangements may need to be made for infirm or handicapped people.

DON'T use equipment such as personal stereos or radios so that you are distracted from the requirements of traffic safety. It is illegal to watch television whilst driving.

DON'T listen to headphones at high volume as such use can permanently damage your hearing.

DON'T obstruct the ventilation of the equipment, for example with curtains or soft furnishings.

Overheating will cause damage and shorten the life of the equipment.

DON'T use makeshift stands and NEVER fix legs with wood screws — to ensure complete safety always fit the manufacturer's approved stand or legs with the fixings provided according to the instructions.

DON'T allow electrical equipment to be exposed to rain or moisture.

### ABOVE ALL

- NEVER let anyone, especially children, push anything into holes, slots or any other opening in the case—this could result in a fatal electrical shock.
  
- NEVER guess or take chances with electrical equipment of any kind—it is better to be safe than sorry!

# Introduction

---

We would like to thank you for purchasing one of our JVC products. Before operating this unit, read this manual carefully and thoroughly to obtain the best possible performance from your unit, and retain this manual for future reference.

## About This Manual

---

This manual is organized as follows:

- This manual mainly explains playback and editing operations using the remote control, and the other operation such as recording operations using the buttons on the unit. You can use the buttons both on the remote control and on the main unit for the same operations if they have the same or similar names (or marks), unless mentioned otherwise.
- Basic and common information that is the same for many functions is grouped in one place, and is not repeated in each procedure. For instance, we do not repeat the information about turning on/off the unit, setting the volume, changing the sound effects, and others, which are explained in the section “Basic Settings” on pages 10 – 12 and “Basic and Common Operations” on pages 13 – 15.
- The following marks are used in this manual:



Gives you warnings and cautions to prevent from damage or risk of fire/electric shock. Furthermore, gives you information which is not good for obtaining the best possible performance from the unit.



Gives you information and hints you had better know.

## Precautions

---

### Installation

- Install in a place which is level, dry and neither too hot nor too cold—between 5°C (41°F) and 35°C (95°F).
- Install the unit in a location with adequate ventilation to prevent internal heat buildup in the unit.
- Leave sufficient distance between the unit and the TV.
- Keep the speakers away from the TV to avoid interference with TV.



DO NOT install the unit in a location near heat sources, or in a place subject to direct sunlight, excessive dust or vibration.

### Power sources

- When unplugging the unit from the wall outlet, always pull the plug, not the AC power cord.



DO NOT handle the AC power cord with wet hands.

### Moisture condensation

Moisture may condense on the lens inside the unit in the following cases:

- After starting heating in the room
  - In a damp room
  - If the unit is brought directly from a cold to a warm place
- Should this occur, the unit may malfunction. In this case, leave the unit turned on for a few hours until the moisture evaporates, unplug the AC power cord, then plug it in again.

### Others

- Should any metallic object or liquid fall into the unit, unplug the unit and consult your dealer before operating any further.
- If you are not going to operate the unit for an extended period of time, unplug the AC power cord from the wall outlet.



DO NOT disassemble the unit since there are no user serviceable parts inside.

If anything goes wrong, unplug the AC power cord and consult your dealer.

# Contents

<b>Location of the Buttons .....</b>	<b>3</b>	<b>Playing Back PC and</b>	
Front Panel .....	3	<b>Changing the Source Name .....</b>	<b>33</b>
Remote Control .....	5	Playing Back PC Sound Files .....	34
<b>Getting Started.....</b>	<b>6</b>	Installing USB Drivers .....	35
Unpacking .....	6	Changing the Source Name .....	36
Connecting Antennas .....	6	<b>Recording on MDs .....</b>	<b>37</b>
Connecting Speakers .....	7	Before You Start Recording .....	38
Connecting Other Equipment .....	8	Adjusting the Recording Level .....	40
Putting the Batteries into the Remote Control .....	9	Setting Group Recording Function .....	41
<b>Basic Settings .....</b>	<b>10</b>	Recording CDs—CD Synchronized Recording ..	42
Turning On the Power .....	11	Recording FM/AM (MW/LW) Broadcasts .....	43
Setting the Clock .....	11	Recording the External Equipment	
Changing the Display Brightness .....	12	—Sound Synchronized Recording .....	43
Changing the Display Contrast .....	12	<b>Editing MDs .....</b>	<b>45</b>
Setting the Auto Power Off .....	12	Guidance—MD Group Functions .....	46
<b>Basic and Common Operations .....</b>	<b>13</b>	Introducing Group Editing Functions .....	47
Selecting the Sources and Starting Play .....	14	Forming a Group—FORM GR .....	48
Adjusting the Volume .....	14	Adding a Track to a Group—ENTRY GR .....	49
Reinforcing the Bass Sound .....	15	Dividing a Group—DIVIDE GR .....	50
Adjusting the Bass and Treble Sounds .....	15	Joining Two Groups—JOIN GR .....	51
<b>Listening to FM and AM (MW/LW)</b>		Moving a Group—MOVE GR .....	52
<b>Broadcasts .....</b>	<b>16</b>	Ungrouping Tracks—UNGROUP .....	53
Tuning into a Station .....	17	Dissolving All Groups—UNGR ALL .....	53
Presetting Stations .....	17	Erasing Tracks in a Group—ERASE GR .....	54
Tuning into a Preset Station .....	18	Introducing Track Editing Functions .....	55
Receiving FM Stations with RDS .....	19	Dividing a Track—DIVIDE .....	56
Changing the RDS Information .....	19	Joining Two Tracks—JOIN .....	57
Searching for Programs by PTY Codes		Moving a Track—MOVE .....	58
(PTY Search) .....	19	Erasing Tracks—ERASE .....	59
Switching to a Program Type of Your Choice		Erasing All Tracks—ALL ERASE .....	59
Temporarily .....	20	<b>Making Your Own Titles .....</b>	<b>60</b>
• How the EON function actually works .....	21	Assigning Titles to an MD .....	61
• Description of the PTY codes .....	22	Changing Titles .....	63
<b>Playing Back CDs (CD/CD-R/CD-RW) .....</b>	<b>23</b>	<b>Using the Timers .....</b>	<b>64</b>
Precautions on CD Playback .....	24	Using Recording Timer .....	65
Playing Back the Entire CD—Normal Play .....	24	Using Daily Timer .....	66
Basic CD Operations .....	25	Using Sleep Timer .....	67
Programming the Playing Order of the Tracks		Timer Priority .....	67
—Program Play .....	25	<b>Maintenance .....</b>	<b>68</b>
Playing at Random—Random Play .....	26	<b>Additional Information .....</b>	<b>69</b>
Repeating Tracks or CD—Repeat Play .....	26	MD Disc Types .....	69
<b>Playing Back an MD .....</b>	<b>27</b>	ATRAC (Adaptive TRansform Acoustic Coding)/	
Playing Back the Entire MD—Normal Play .....	28	ATRAC3 (MDLP) .....	69
Basic MD Operations .....	28	UTOC (User Table Of Contents) .....	69
Playing Tracks in a Group—Group Play .....	29	Sound Skip Guard Memory .....	69
Programming the Playing Order of the Tracks		SCMS (Serial Copy Management System) .....	70
—Program Play .....	30	HCMS (High-speed Copy Management System) .....	70
Playing at Random—Random Play .....	31	• MD limitations .....	70
Repeating Tracks or MD—Repeat Play .....	31	<b>Messages .....</b>	<b>71</b>
Searching Tracks to Play		<b>Troubleshooting .....</b>	<b>73</b>
—MD Title Search .....	31	<b>Specifications .....</b>	<b>74</b>
Prohibiting Disc Ejection—Disc Lock .....	32		

# Location of the Buttons

Become familiar with the buttons on your unit.

## Front Panel

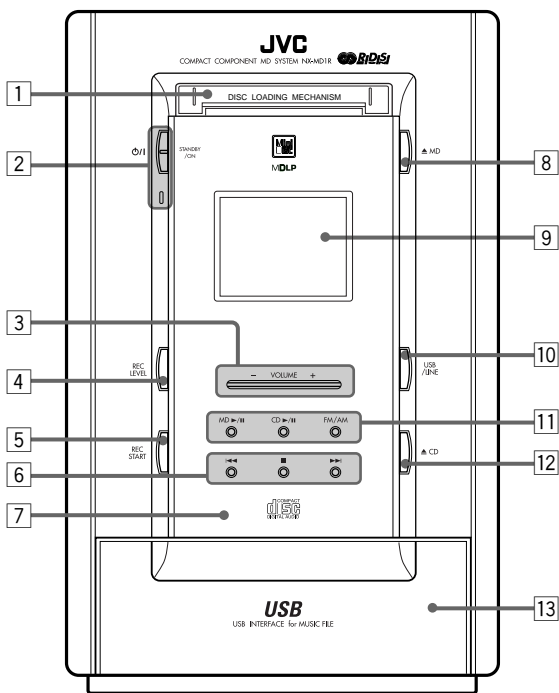

## Inside of Front Door

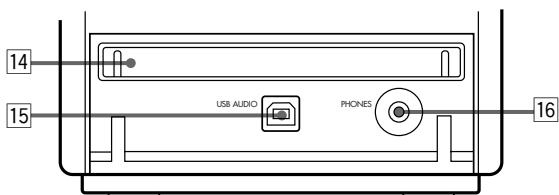

## Display Window

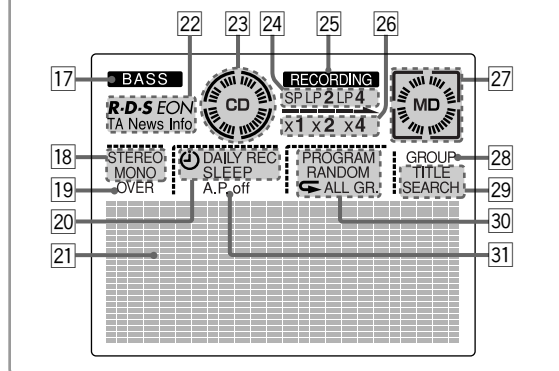



See pages in the parentheses for details.

### Front Panel

- 1 MD loading slot (28)
- 2 STANDBY/ON  $\odot$ /I button and lamp (11, 65, 66)
- 3 VOLUME +, - button and lamp (14, 40, 41)
- 4 REC LEVEL button (40, 41)
- 5 REC START button (42 – 44)
- 6 Multi operation buttons
  - $\lll$ ,  $\blacksquare$ ,  $\ggg$
- 7 Remote sensor (4)
- 8  $\blacktriangle$  (eject) MD button (28)
  - *Pressing this button also turns on the unit.*
- 9 Display window
- 10 USB/LINE button (14, 34 – 36)
  - *Pressing this button also turns on the unit.*
- 11 Source selection and operation buttons
  - MD  $\blacktriangleright$ /II (play/pause) button (14, 28, 39, 44)
  - CD  $\blacktriangleright$ /II (play/pause) button (14, 24, 42)
  - FM/AM button (14, 17)
    - *Pressing one of these buttons also turns on the unit.*
- 12  $\blacktriangle$  (eject) CD button (24)
  - *Pressing this button also turns on the unit.*
- 13 Front door (4)
- 14 CD tray (24)
- 15 USB AUDIO terminal (34)
- 16 PHONES jack (15)

### Display Window

- 17 BASS indicator (15)
- 18 FM mode indicators (17)
  - STEREO and MONO
- 19 OVER indicator (40, 44)
- 20 Clock and timer mode indicators
  - $\odot$  (clock) (11)
  - DAILY, REC, and SLEEP (65 – 67)
- 21 Main display
  - Shows the source name, track and/or group number, and other information.
- 22 RDS operation indicators (19 – 21)
  - RDS, EON, and TA/News/Info
- 23 CD indicator (25)
- 24 Recording length mode indicators (42)
  - SP, LP2, and LP4
- 25 RECORDING indicator (42 – 44)
- 26 Recording speed indicators (40, 42)
  - x1, x2, and x4
- 27 MD indicator (29)
- 28 GROUP indicator (41 – 44, 49 – 59, 61)
- 29 TITLE SEARCH indicator (31)
- 30 MD/CD play mode and repeat mode indicators (25, 26, 29 – 31)
  - PROGRAM, RANDOM, GR. (group) and repeat ( $\hookrightarrow$ /ALL)
- 31 A.P.off indicator (12)

### How to Open the Front Door Manually

- 1 Push on the lower part of the door.

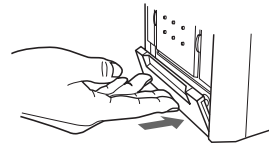

- 2 Pull down the door slowly until it clicks.

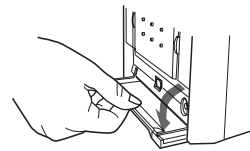

To close the door, push it up slowly.

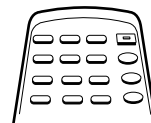
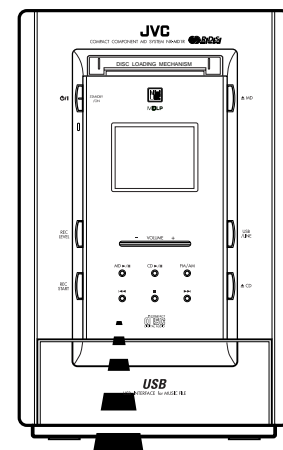
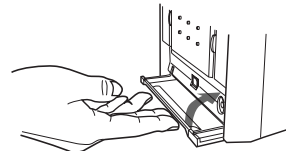

When using the remote control, point it at the remote sensor on the front panel.

## Remote Control

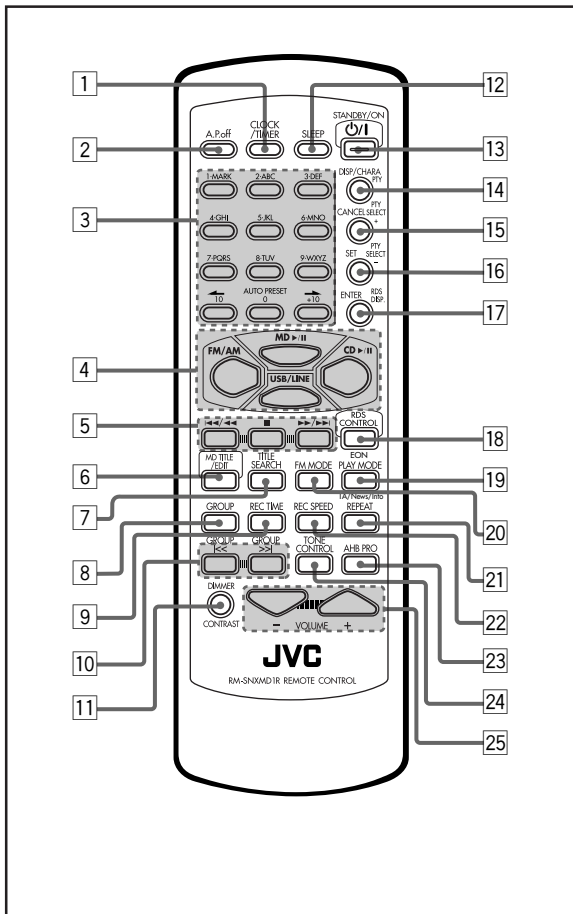

### \* When using the remote control:

**For RDS operations**, press RDS CONTROL on the remote control first when using the buttons (14) – (17), (19), (21).

- After using RDS operations, make sure to change the operation mode of the remote control to the one you want to use by pressing CD ►/||, FM/AM, MD ►/||, or USB/LINE (4).

- 1 CLOCK/TIMER button (11, 65, 66)
- 2 A.P.off button (12)
- 3\* Number buttons
  - 1 – 10, +10 buttons (18, 25, 29)
  - Character entry buttons (A – Z, 0 – 9) (32, 62)
  - ◀ (10), ▶ (+10) buttons (32, 62)
  - MARK button (32, 62)
  - AUTO PRESET button (17)
- 4\* Source selection and operation buttons
  - FM/AM button (14, 17)
  - MD ►/|| (play/pause) button (14, 28, 39, 44)
  - CD ►/|| (play/pause) button (14, 24, 42)
  - USB/LINE button (14, 34 – 36, 41)
    - Pressing one of these buttons also turns on the unit.
- 5 Multi operation buttons
  - ◀◀/▶▶, ◀, ▶▶/▶▶
- 6 MD TITLE/EDIT button (39, 48 – 59, 61, 62)
- 7 TITLE SEARCH button (31)
- 8 GROUP button (41 – 43, 49 – 59, 61)
- 9 REC TIME button (39, 42 – 44)
- 10 GROUP ◀◀, ▶▶ buttons (28, 29, 49 – 54, 61)
- 11 DIMMER button (11, 12)
- 12 CONTRAST button (12)
- 13 SLEEP button (67)
- 14 STANDBY/ON ◊/I button (11, 65, 66)
- 15 DISP./CHARA button (17, 25, 29, 32, 34, 39, 42 – 44, 61)
  - \* PTY button (19, 20)
- 16 CANCEL button (11, 26, 30, 32, 48 – 59, 63, 65, 66)
  - \* PTY SELECT + button (19)
- 17 SET button (11, 18, 36, 38, 43, 48 – 59, 61, 65, 66)
  - \* PTY SELECT – button (19)
- 18 ENTER button (12, 32, 48 – 59, 62)
  - \* RDS DISP. button (19)
- 19 RDS CONTROL button (19, 20)
- 20 PLAY MODE button (25, 26, 29 – 31)
  - \* EON button (20)
- 21 FM MODE button (17)
- 22 REPEAT button (26, 31)
  - \* TA/News/Info button (20)
- 23 REC SPEED button (40, 42)
- 24 AHB PRO button (15)
- 25 TONE CONTROL button (15)
- 26 VOLUME +, – buttons (14, 15, 40, 41)

## Unpacking

After unpacking, check to be sure that you have all the following items.

The number in the parentheses indicates the quantity of the pieces supplied.

- FM antenna (1)
- AM loop antenna (1)
- Remote control (1)
- Batteries (2)
- AC power cord (1)

If any is missing, consult your dealer immediately.

## Connecting Antennas

### FM antenna

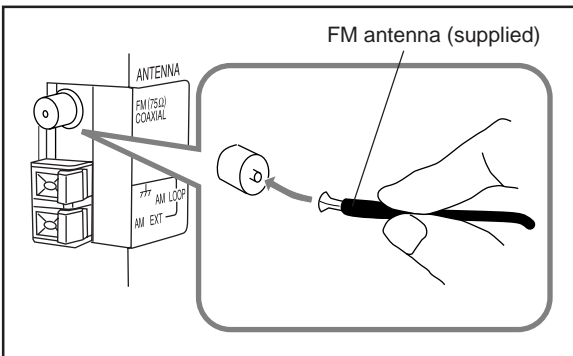

- 1** Attach the FM antenna to the FM (75 Ω) COAXIAL terminal.
- 2** Extend the FM antenna.
- 3** Fasten it up in the position which gives you the best reception.



#### About the supplied FM antenna

The FM antenna supplied with this unit can be used as temporary measure. If reception is poor, you can connect an outdoor FM antenna.

### To connect an outdoor FM antenna

Before connecting it, disconnect the supplied FM antenna.

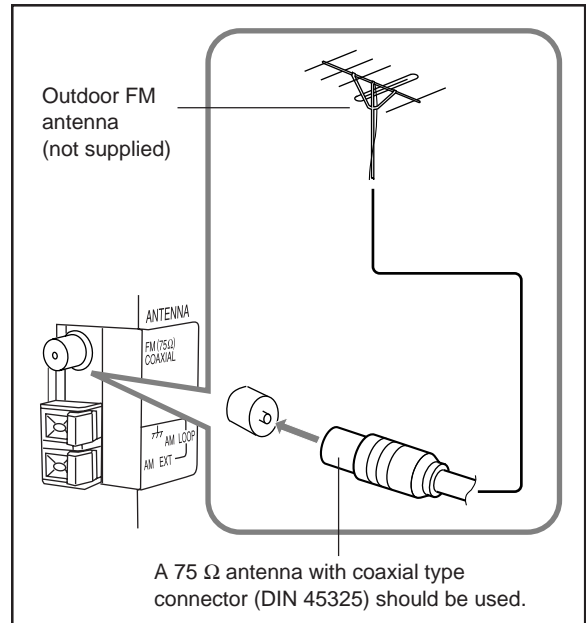

## AM antenna

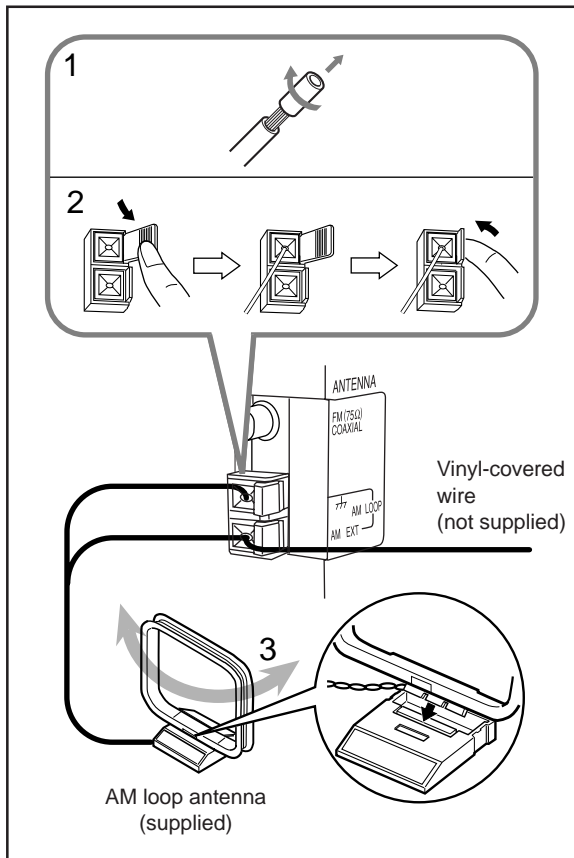

- 1** If cords are covered with insulation, twist the core of the cord at the end of each cord, then remove the insulation.
- 2** Connect the AM loop antenna to the AM LOOP terminals as illustrated.
- 3** Turn the AM loop antenna until you have the best reception.

### To connect an outdoor AM antenna

When reception is poor, connect a single vinyl-covered wire to the AM EXT terminal and extend it horizontally. (The AM loop antenna must remain connected.)



#### For better reception of both FM and AM (MW/LW)

- Make sure the antenna conductors do not touch any other terminals and connecting cords.
- Keep the antennas away from metallic parts of the unit, connecting cords, and the AC power cord.

## Connecting Speakers

You can connect the speakers using the speaker cords.

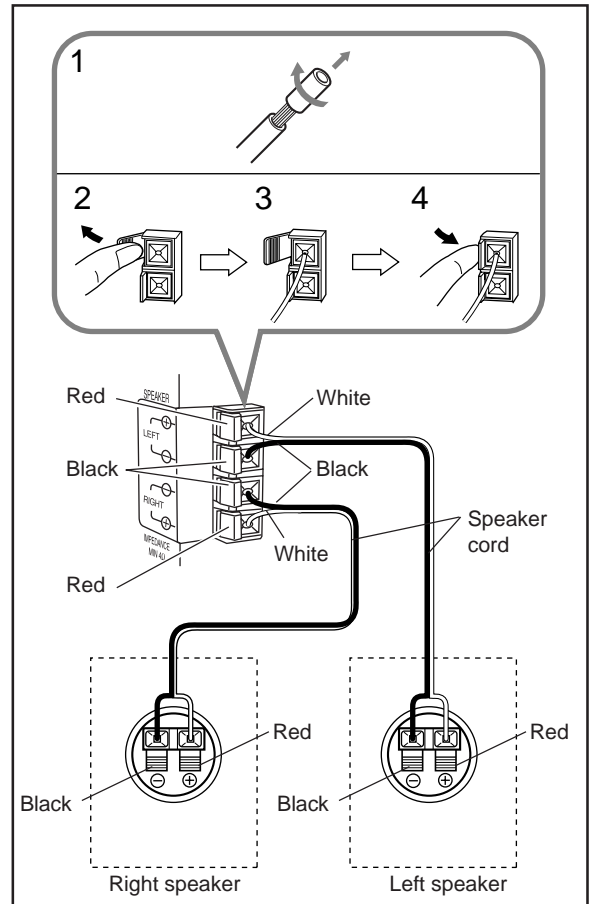

- 1** If cords are covered with insulation, twist the core of the cord at the end of each cord, then remove the insulation.
- 2** Open the speaker terminal.
- 3** Insert the end of the speaker cord to the terminal. Match the polarity of the speaker terminals: White (+) to red (+) and black (-) to black (-).
- 4** Close the speaker terminal on the rear of the unit.

Use only speakers with the same speaker impedance—more than 4  $\Omega$ —as indicated by the speaker terminals on the rear of the unit.

## To remove the speaker grille

The speaker grilles are removable as shown below:

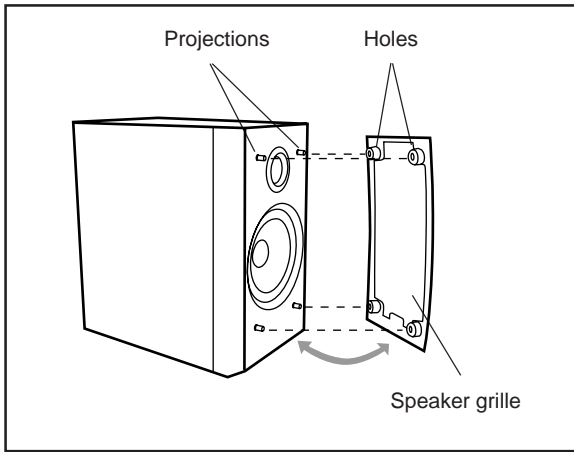

**To remove the speaker grille**, insert your fingers at the top of the speaker grille, then pull towards you. Do the same at the bottom.

**To attach the speaker grille**, put the projections of the speaker into the holes of the speaker grille.

## Connecting Other Equipment

You can connect the following equipment to this unit:

- Cassette deck—used as a playback and recording device. By using the cassette deck, you can record any source played back on this unit.
- Audio equipment with an optical digital output terminal—used only as a digital playback device.
- PC with a USB port—used only as a digital playback device (for details, see pages 33 to 36).

When you connect and use these equipment, refer also to the manuals supplied with them.



- DO NOT connect other equipment while the power is on.
- DO NOT plug in any equipment until all connections are complete.

### To connect another component such as a cassette deck

Be sure that the plugs of the audio cords and the jacks on the rear of the unit are color coded: White plugs and jacks are for left audio signals, and red ones for right audio signals.

By using audio cords (not supplied), connect:

- Between the audio input jacks on the cassette deck and the LINE OUT jacks—For recording on the cassette deck.
- Between the audio output jacks on the cassette deck and the LINE IN jacks—For playing a tape.

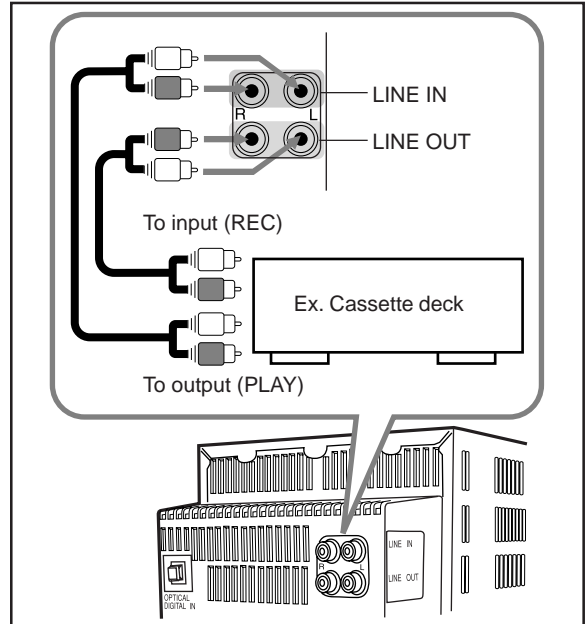

### To connect audio equipment with an optical digital output terminal

Connect between the optical digital output terminal on the other equipment and the OPTICAL DIGITAL IN terminal.

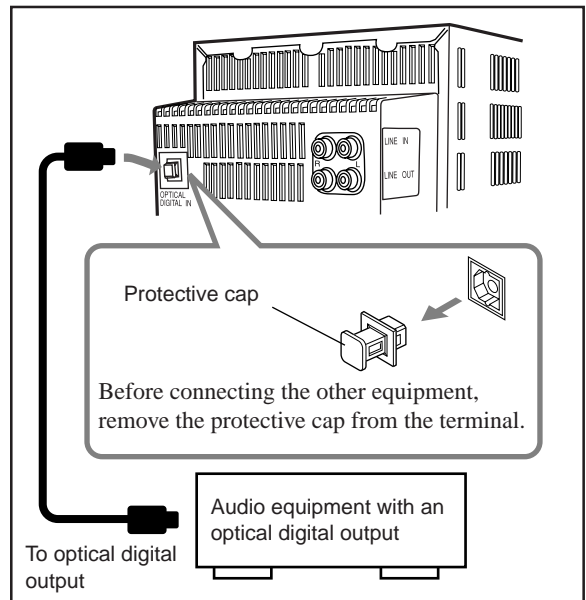

**NOW, you can plug in the unit and other connected equipment FINALLY!**

**IMPORTANT:** Be sure to check all connections to be done before plugging the AC power cord into a wall outlet.

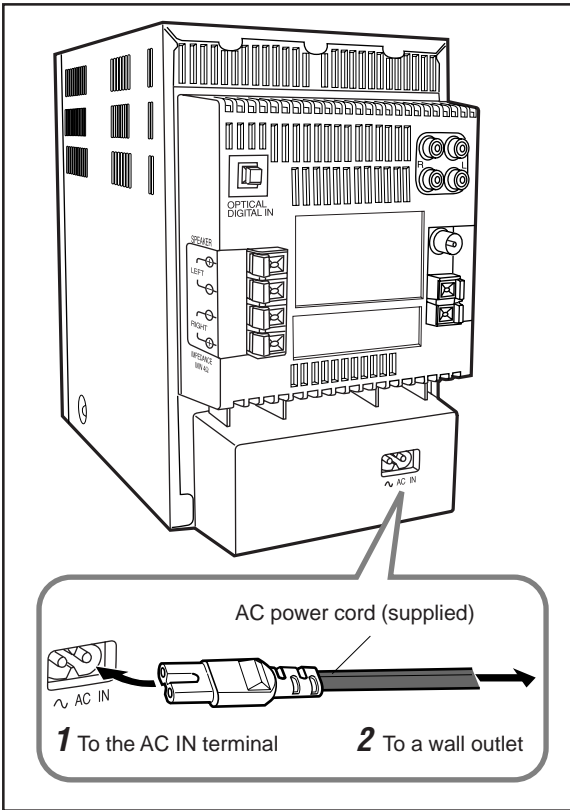

## Putting the Batteries into the Remote Control

Insert the batteries—R6P(SUM-3)/AA(15F)—into the remote control, by matching the polarity (+ and -) on the batteries with the + and - markings on the battery compartment.

When the remote control can no longer operate the unit, replace both batteries at the same time.

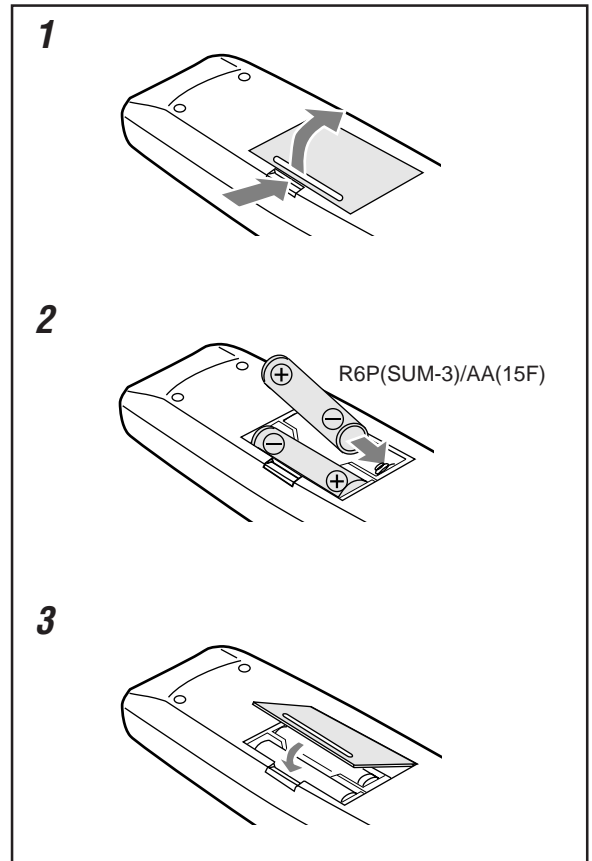

- DO NOT use an old battery together with a new one.
- DO NOT use different types of batteries together.
- DO NOT expose batteries to heat or flame.
- DO NOT leave the batteries in the battery compartment when you are not going to use the remote control for an extended period of time. Otherwise, it will be damaged from battery leakage.

The buttons enlarged in the illustration below are used and explained in this section (pages 11 and 12).

## Remote control

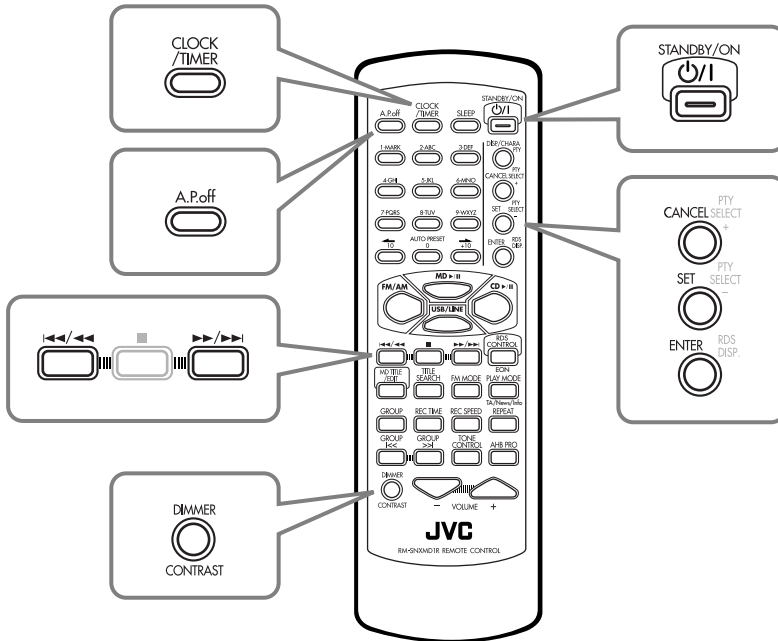

## Front panel

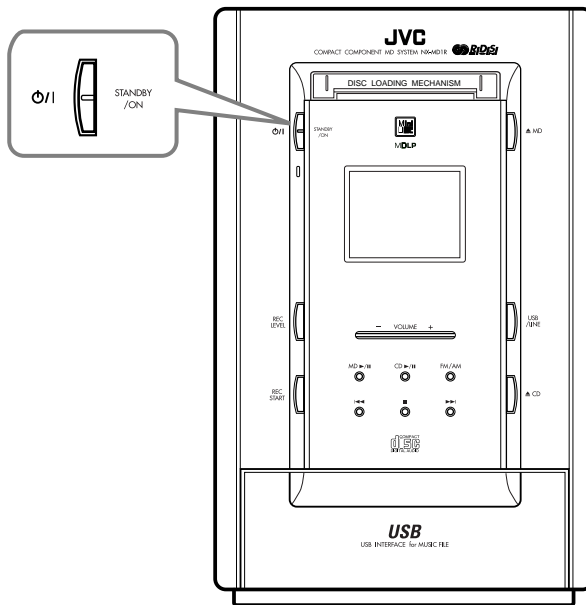

Before operating the unit any further, first set the clock built in this unit, then some other basic settings.

## Turning On the Power

When you press the play button (▶/⏪) for a particular source or the source selecting buttons such as FM/AM and USB/LINE, the unit automatically turns on (and starts playback if the source is ready).

To turn on the unit without playing, press STANDBY/ON ⏻ so that the STANDBY/ON lamp on the unit lights green.

The digital display shows the word "HELLO" in a large, blocky font.

- The ⏻ indicator starts flashing if the built-in clock is not set.

To turn off the unit (on standby), press STANDBY/ON ⏻ again so that the STANDBY/ON lamp lights red.

The digital display shows the words "SEE YOU" in a large, blocky font.

A little power is always consumed even while the unit is in standby mode.

To switch off the power supply completely, unplug the AC power cord from the AC outlet.



When you unplug the AC power cord or if a power failure occurs

The clock is reset to “0:00” after about a minute, while the tuner preset stations and other settings will be erased in a few days.

## Setting the Clock

You can set the clock whether the unit is turned on or in standby mode.

### On the remote control ONLY:

- 1 Press CLOCK/TIMER.  
The hour digit in the main display starts flashing.

The digital display shows "0:00" with the hour digit "0" flashing. Below it, "OK? SET" is displayed.

- 2 Press ▶▶/▶▶| or ◀◀/◀◀ repeatedly to adjust the hour.

- When you press and hold the button, the hour digit changes continuously.

- 3 Press SET to set the hour.  
The minute digits start flashing.

The digital display shows "15:00" with the minute digits "00" flashing. Below it, "OK? SET" is displayed.

- If you want to correct the hour after pressing SET, press CANCEL. The hour digit starts flashing again.

- 4 Press ▶▶/▶▶| or ◀◀/◀◀ repeatedly to adjust the minute.

- When you press and hold the button, the minute digit changes continuously.

- 5 Press SET to finish setting the clock.  
“ADJUST OK” appears in the main display, and the built-in clock starts.  
The ⏻ indicator stops flashing and remains lit.

### To adjust the clock again

Once you have adjusted the clock, you need to press CLOCK/TIMER repeatedly until the clock setting screen appears in the main display (the hour digit starts flashing).

### To turn on the clock indication

You can turn on the clock indication on the display while the unit is in standby mode.

#### On the remote control ONLY:

Press DIMMER (CONTRAST) while the unit is in standby mode.

The clock indication appears on the display.

To turn off the clock indication for saving the power again, press DIMMER (CONTRAST) while the unit is in standby mode.



## Changing the Display Brightness

You can change the display brightness while the unit is turned on.

### On the remote control ONLY:

Press **DIMMER (CONTRAST)**.

The display illumination dims and the volume lamp goes off.

- Each time you press the button, the display brightness alternates between normal mode and dimmer mode.

## Changing the Display Contrast

You can change the display contrast while the unit is turned on.

### On the remote control ONLY:

- 1 Press and hold **CONTRAST (DIMMER)** for more than 2 seconds.  
"CONTRAST" and the current setting appear in the main display.



- 2 Press **▶▶/▶▶|** or **◀◀/◀◀** repeatedly to adjust the contrast.

- You can adjust the contrast within the range of 0 to +7.



- 3 Press **ENTER** to finish setting.

- If you do not press the button about 60 seconds, the setting will also be stored, then the source indication will be resumed.

## Setting the Auto Power Off

Auto Power Off function automatically turns off the unit if no sound comes in for more than 3 minutes except when FM or AM (MW/LW) is selected as the source.

If any operation is done during this 3-minute period, Auto Power Off is canceled temporarily even though no sound comes in.

### On the remote control ONLY:

To activate **Auto Power Off**, press **A.P.off**.

The **A.P.off** indicator lights up on the display and "A.P.off SET" appears in the main display.

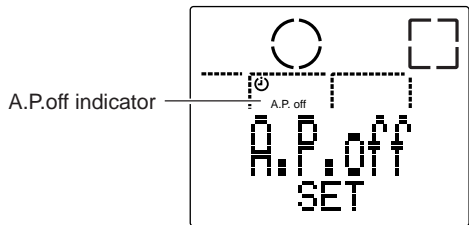

- When no sound comes in, the **A.P.off** indicator starts flashing on the display. About 20 seconds before the unit turns itself off, the unit starts counting down the time.



To deactivate **Auto Power Off**, press **A.P.off**.

The **A.P.off** indicator goes off from the display and "A.P.off CANCEL" appears in the main display.

# Basic and Common Operations

The buttons enlarged in the illustration below are used and explained in this section (pages 14 and 15).

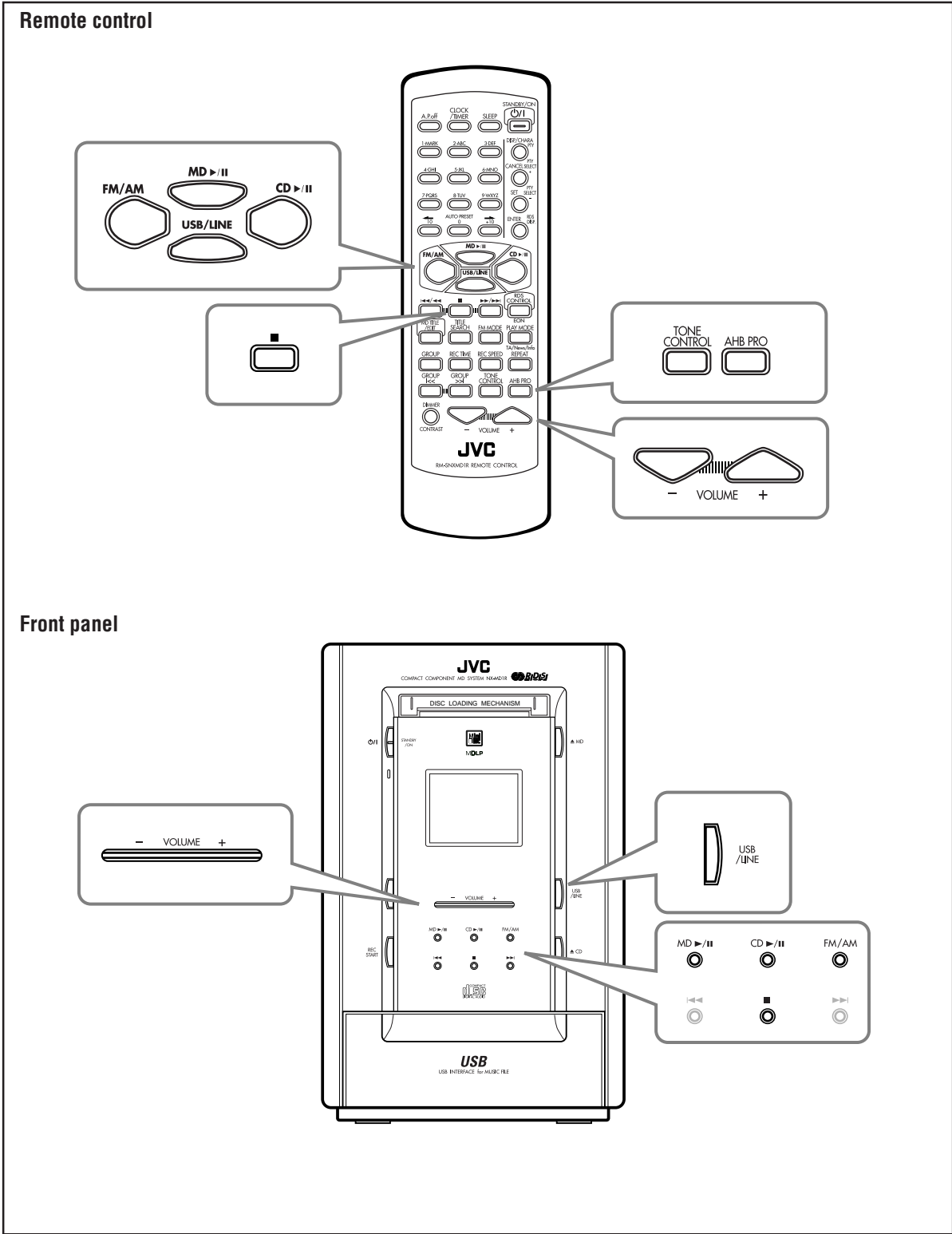

## Selecting the Sources and Starting Play

To select the tuner as the source, press FM/AM.

When the unit is in standby mode:

The unit automatically turns on, and the unit starts to tune into the last received station.

When the unit is turned on:

“FM” or “AM” appears in the main display for a while, and the unit starts to tune in the last received station.

- Each time you press the button, the band alternates between “FM” or “AM” (MW/LW).
- For more detailed operations, see pages 16 to 22.

To select the CD player as the source, press CD ►/II.

When the unit is in standby mode:

The unit automatically turns on.

When the unit is turned on:

“CD PLAY” appears in the main display for a while.

- Playback will start if a CD is on the CD tray.
- “CD NO DISC” will appear in the main display if a CD is not loaded.

To stop playback, press ■.

- For more detailed operations, see pages 23 to 26.

To select the MD player as the source, press MD ►/II.

When the unit is in standby mode:

The unit automatically turns on.

When the unit is turned on:

“MD PLAY” appears in the main display for a while.

- Playback will start if an MD is in the MD loading slot.
- “MD NO DISC” will appear in the main display if an MD is not loaded.

To stop playback, press ■.

- For more detailed operations, see pages 27 to 32.

To select the external equipment as the source, press USB/LINE.

The unit automatically turns on (when the unit is in standby), and the source name selected previously appears in the main display.

- Each time you press the button (while the unit is on), the source changes as follows:



**USB** : To use PC connected to the USB AUDIO terminal.

**LINE** : To use the equipment connected to the LINE IN jacks.  
The recording level appears for a while. (See page 41 for the recording level.)

**DIGITAL IN** : To use the digital equipment connected to the OPTICAL DIGITAL IN terminal.

- If you have changed the source name, the changed name will appear. (See page 36.)
- For details on USB, see pages 33 to 36.
- For operating the external equipment, see the manuals supplied with them.



**While selecting the digital equipment (“DIGITAL IN”) as the source**

The sampling frequency of the connected digital equipment is shown in the main display. (If no equipment is connected to the OPTICAL DIGITAL IN terminal or the equipment is not connected appropriately, “UNLOCK” appears.)

DIGITAL IN  
44.1kHz

Ex. When the sampling frequency is 44.1 kHz

## Adjusting the Volume

You can adjust the volume level only while the unit is turned on.

To decrease the volume, press VOLUME – .

To increase the volume, press VOLUME + .

VOLUME 12  
|||||

- You can adjust the volume within the range of 0 to 50.
- When you press and hold the button, the volume level changes continuously.



### For private listening

Connect a pair of headphones to the PHONES jack inside the front door. No sound comes out of the speakers. Be sure to turn down the volume before connecting or putting on the headphones.



### If “CANNOT LISTEN!” appears in the main display

During high-speed recording (see page 40), you cannot listen to any source, and therefore, cannot adjust the volume level.



DO NOT turn off (on standby) the unit with the volume set to an extremely high level; otherwise, the sudden blast of sound can damage your hearing, speakers and/or headphones when you turn on the unit or start playing any source. REMEMBER you cannot adjust the volume level while the unit is in standby mode.

## Reinforcing the Bass Sound

The richness and fullness of the bass sound is clearly maintained regardless of how low you set the volume —Active Hyper Bass Pro.

- You can use this effect only for playback.
- This function also effects the sound from headphones.

### On the remote control ONLY:

To get the effect, press AHB PRO repeatedly until “AHB 1” or “AHB 2” appears in the main display. The BASS indicator lights up on the display.

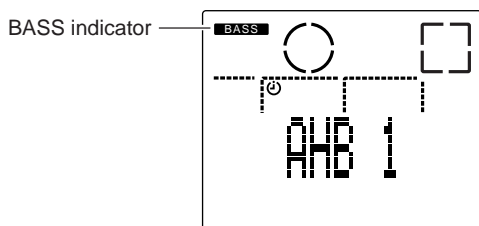

- Each time you press the button, the Active Hyper Bass Pro mode changes as follows:

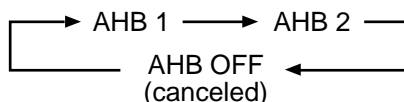

- “AHB 2” is more effective than “AHB 1.”

To cancel the effect, press AHB PRO repeatedly until “AHB OFF” appears in the main display. The BASS indicator goes off from the display.

## Adjusting the Bass and Treble Sounds

You can adjust bass and treble sound effects to your taste and surroundings.

- You can use this effect only for playback.
- This function also effects the sound from headphones.

### On the remote control ONLY:

- 1 Press TONE CONTROL to select “BASS” or “TREBLE.”

The selected tone control mode and the current setting appear in the main display.



Ex. “BASS” is selected

- Each time you press the button, the tone control mode changes as follows:

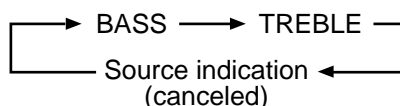

- 2 Press VOLUME + or – to adjust the selected tone level.

- You can adjust the tone level within the range of –5 to +5.



Ex. “BASS” level is set to “+3”

- 3 Repeat steps 1 and 2 to adjust the other tone level.

- 4 Press TONE CONTROL to finish the setting.

- If you do not press the button about 5 seconds, the setting will be also stored, then the source indication will be resumed.

# Listening to FM and AM (MW/LW) Broadcasts

The buttons enlarged in the illustration below are used and explained in this section (pages 17 to 22).

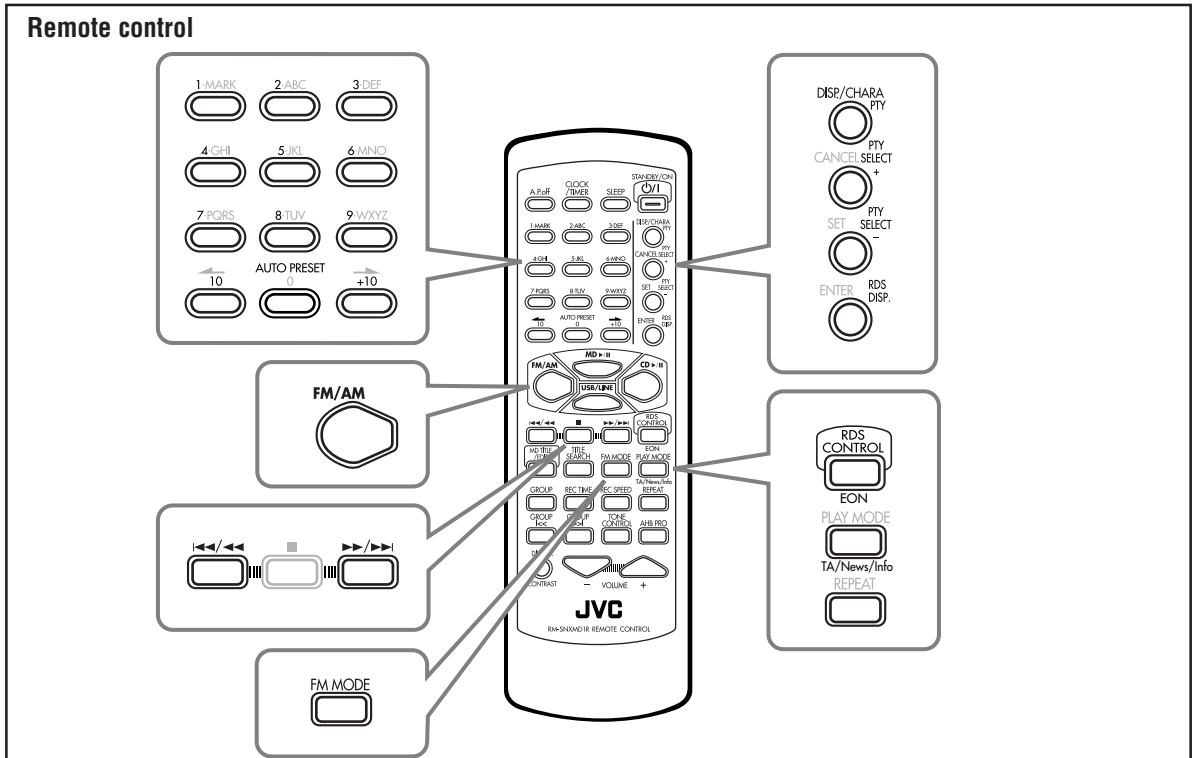

**You cannot use the buttons on the front panel to operate the RDS functions. Use only buttons on the remote control.**

## Front panel

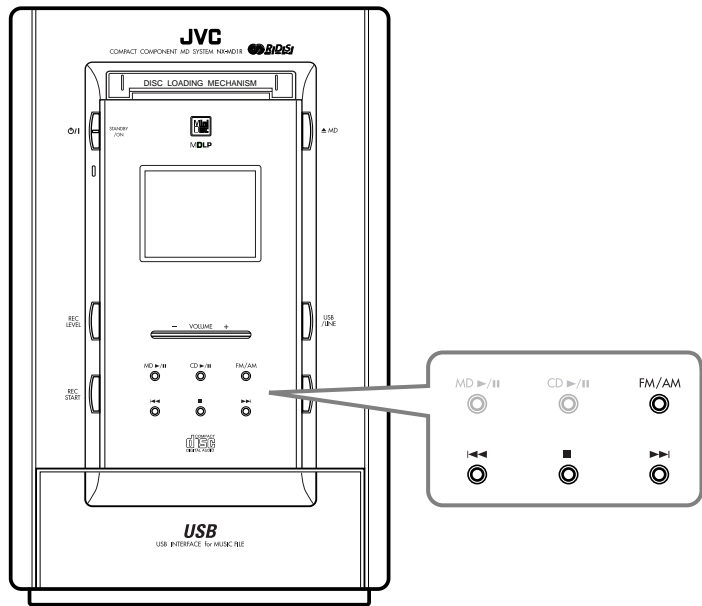

## Tuning into a Station

### 1 Press FM/AM.

- The unit automatically turns on and tunes into the previously tuned station (either FM or AM–MW/LW).
- Each time you press the button, the band alternates between FM and AM (MW/LW).

FM  
91.50MHz

### 2 Tune into a station.

#### On the remote control:

Press and hold **▶▶/▶▶** or **◀◀/◀◀** until the station frequencies start changing in the main display.

- **▶▶/▶▶** : to increase the frequencies.
- **◀◀/◀◀** : to decrease the frequencies.

#### On the unit:

Press and hold **▶▶** or **◀◀** until the station frequencies start changing in the main display.

- **▶▶** : to increase the frequencies.
- **◀◀** : to decrease the frequencies.

The unit starts searching for stations and stops when a station of sufficient signal strength is tuned in.

- If an FM program is broadcast in stereo, the STEREO indicator lights.

To stop during searching, press **▶▶/▶▶** or **◀◀/◀◀** (**▶▶** or **◀◀** on the unit).



When you repeatedly press **▶▶/▶▶** or **◀◀/◀◀** (**▶▶** or **◀◀** on the unit)

The frequency changes step by step.

### To change the FM reception mode

When an FM stereo broadcast is noisy or hard to receive, you can change the FM reception mode to improve the reception.

#### On the remote control ONLY:

Press **FM MODE**.

- Each time you press the button, FM reception mode alternates between “FM AUTO” and “FM MONO.”

**FM AUTO** : Normally select this. In this mode, you can hear stereo sound when a program is broadcast in stereo.

**FM MONO** : Select this when an FM stereo broadcast is noisy or hard to receive. Reception improves though stereo effect is lost. The MONO indicator lights up on the display.

### To change the information shown in the main display

#### On the remote control ONLY:

Each time you press **DISP./CHARA**, the information in the main display alternates between the source indication and the clock indication.

## Presetting Stations

You can preset 30 FM and 15 AM (MW/LW) stations—using either automatic presetting method or manual presetting method.

In some cases, test frequencies have been already memorized for the tuner since the factory examined the tuner preset function before shipment. This is not a malfunction. You can preset the stations you want into memory by following the presetting method.

### To preset stations automatically—Automatic Presetting

#### On the remote control ONLY:

You need to preset stations separately for the FM and AM bands.

### 1 Press FM/AM to select the band.

### 2 Press and hold **AUTO PRESET** for about 2 seconds until “**AUTO PRESET**” appears in the main display.

Local stations with strong signals are searched for and stored in memory automatically.

When automatic presetting is over, the station stored in preset number 1 is received.

FM 1  
91.50MHz

### 3 Repeat steps 1 and 2 to store stations of the other band.



When you cannot store stations you want automatically

Stations with weak signals cannot be detected with this automatic presetting method. To store such a station, use the manual presetting method on page 18.

**To preset stations manually—Manual Presetting**

- There is a time limit in doing the following steps. If the setting is canceled before you finish, start from step 2 again.

**On the remote control ONLY:****1 Tune into the station you want to preset.**

- See “Tuning into a Station” on page 17.

FM  
91.50MHz

**2 Press SET.**

The preset number 1 starts flashing.

FM 1  
91.50MHz  
STORE?→SET

**3 Press the number buttons to select a preset number.**

- Ex. For preset number 5, press 5.  
For preset number 15, press +10, then 5.  
For preset number 20, press +10, then 10.

FM 5  
91.50MHz  
STORE?→SET

Ex. When number 5 is selected  
for a new preset station

**4 Press SET again.**

“STORED” appears in the main display.  
The tuned station in step 1 is stored in the preset number selected in step 3.

FM 5  
91.50MHz  
STORED

- Storing a new station on a used number erases the previously stored one.

**Tuning into a Preset Station****1 Press FM/AM.**

The unit automatically turns on and tunes into the previously tuned station (either FM or AM–MW/LW).

- Each time you press the button, the band alternates between FM and AM (MW/LW).

FM  
91.50MHz

**2 Select a preset number.****On the remote control:**

**Press the number buttons.**

Ex. For preset number 5, press 5.

For preset number 15, press +10, then 5.

For preset number 20, press +10, then 10.

**On the unit:**

**Press  repeatedly.**

Each time you press the button, the preset number increases in order. If you press the button at the last preset number, the preset number will start from number 1.

FM 5  
91.50MHz

Ex. When number 5 is selected



**When you unplug the AC power cord or if a power failure occurs**

The preset stations will be erased in a few days. If this happens, preset the stations again.

## Receiving FM Stations with RDS

RDS allows FM stations to send an additional signal along with their regular program signals. For example, the stations send their station names, as well as information about what type of program they broadcast, such as sports or music, etc.

When tuned into an FM station which provides the RDS service, the RDS indicator lights on the display.

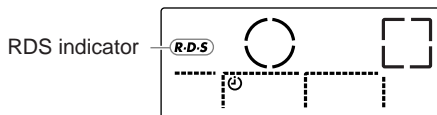

With the unit, you can receive the following types of RDS signals.

### PS (Program Service):

Shows commonly known station names.

### PTY (Program Type):

Shows types of broadcast programs.

### RT (Radio Text):

Shows text messages the station sends.

### EON (Enhanced Other Networks):

Provides the information about the types of the programs sent by other RDS stations than the one being received.

RDS operations are possible only using the remote control. You can use the buttons printed in orange on the remote control. When you select the other sources, the buttons do not work for RDS operations.



#### More about RDS

- Not all FM stations provide RDS signals, nor do all RDS stations provide the same services. If in doubt, check with local radio stations for details on RDS in your area.
- RDS may not work correctly if the received station is not transmitting the signals properly or if the signal strength is weak.

## Changing the RDS Information

You can see RDS information on the display while listening to an FM station.

### On the remote control ONLY:

- 1 Press RDS CONTROL while listening to an FM station.

```
FM 5  
91.50MHz  
NO PS
```

- 2 Press RDS DISP.

- Each time you press the button, the indication at the bottom line of the main display changes to show the following information:

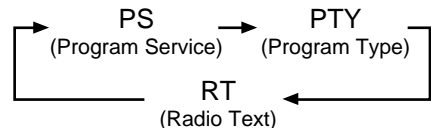

If no PS, PTY, or RT signals are sent by a station “NO PS,” “NO PTY” or “NO RT” appears in the main display.



If the unit takes time to show the RDS information received from a station “WAIT PS,” “WAIT PTY,” or “WAIT RT” may appear in the main display.

## Searching for Programs by PTY Codes (PTY Search)

One of the advantages of RDS is that you can locate a particular kind of program by specifying the PTY codes.

- The PTY Search is applicable only to the preset stations.
- There is a time limit in doing the following steps. If the setting is canceled before you finish, start from step 2 again.

### On the remote control ONLY:

- 1 Press RDS CONTROL while listening to an FM station.

```
FM 5  
91.50MHz  
NO PS
```



## 2 Press PTY.

“PTY SELECT” starts flashing in the main display.



## 3 Press PTY SELECT + or - to select a PTY code while “PTY SELECT” is flashing.



- Each time you press the button, the PTY codes change as follows (refer also to the list on page 22):

None	↔	News	↔	Affairs	↔	Info	↔
Sport	↔	Educate	↔	Drama	↔	Culture	↔
Science	↔	Varied	↔	Pop M	↔	Rock M	↔
Easy M	↔	Light M	↔	Classics	↔		
Other M	↔	Weather	↔	Finance	↔	Children	↔
Social	↔	Religion	↔	Phone In	↔	Travel	↔
Leisure	↔	Jazz	↔	Country	↔	Nation M	↔
Oldies	↔	Folk M	↔	Document	↔	TEST	↔
Alarm!	↔	(back to the beginning)					

## 4 Press PTY again.

While searching, the selected PTY code appears and “SEARCH” flashes in the main display.



Ex. When “Info” is selected

The unit searches 30 preset FM stations, and stops when it finds the one you have selected, and tunes into that station.

### To continue searching after the first stop

Press PTY again while the indications in the main display are flashing. If no program is found, “NOT FOUND” appears in the main display and the unit returns to the last received station.

### To stop searching any time during the process

Press PTY while searching.

## Switching to a Program Type of Your Choice Temporarily

The EON function allows the unit to switch temporarily to a broadcast program of your choice (TA, News, and/or Info) from a different station except when you are listening to a non-RDS station—some FM stations and AM (MW/LW) stations.

- This function only works while receiving a preset RDS station sending the EON data (the RDS and EON indicators light while receiving such a station).
- EON function is applicable only to the preset stations.

### On the remote control ONLY:

## 1 Press RDS CONTROL while listening to an FM station.

## 2 Press EON (PLAY MODE).

The EON data type selected previously—TA/News/Info—lights up on the display.

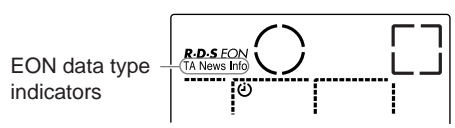

## 3 Press TA/News/Info (REPEAT) repeatedly until the EON data type you want is selected.

- TA** : Traffic announcement
- News** : News
- Info** : Programs the purpose of which is to impart advice in the widest sense.

- Each time you press the button, the EON data types change as follows:

TA	→	News	→	Info	→	TA News	→
News	Info	→	TA	Info	→	TA News	Info
(back to the beginning)							

The indicator(s) corresponding to the selected EON data type lights up on the display.

**To cancel the EON function**, press EON (PLAY MODE) again so that the TA/News/Info indicator goes off.

- If you cancel the EON function while receiving a program selected by the EON function, the unit goes back to the previously tuned station.

## How the EON function actually works:

### CASE 1

#### If there is no station broadcasting the program you have selected

The unit continues tuning in the current station.



When a station starts broadcasting the program you have selected, the unit automatically switches to the station. The indicator of received PTY code starts flashing.



When the program is over, “EON END” appears in the main display, and the unit goes back to the previously tuned station, but the EON function still remains activated.

### CASE 2

#### If there is a station broadcasting the program you have selected

The unit tunes in the program. The indicator of received PTY code starts flashing.



When the program is over, “EON END” appears in the main display, and the unit goes back to the previously tuned station, but the EON function still remains activated.

### CASE 3

#### If the FM station you are listening to is broadcasting the program you have selected

The unit continues to receive the station but the indicator of received PTY code starts flashing.



When the program is over, the indicator of received PTY code stops flashing and remains lit, but the EON function still remains activated.

## Alarm function

If an “Alarm!” (Emergency) signal is received from a station while listening to an RDS station sending the EON data, the unit automatically switches to the station broadcasting the “Alarm!” signal.

## Test function

The TEST signal is used for testing the “Alarm!” signal. Therefore, it makes the unit work in the same way as the “Alarm!” signal does.

If a TEST signal is received from a station while listening to an RDS station sending the EON data, the unit automatically switches to the station broadcasting the TEST signal.



## More about the EON function

- EON data sent from some stations may not be compatible with this unit.
- While listening to a program tuned in by the EON function, the station does not change even if another network station starts broadcasting a program of the same EON data.
- While listening to a program tuned in by the EON function, you can only use the EON and RDS DISP. buttons as the tuner operation buttons. If you press any other tuner operation button, “EON LOCKED!” appears in the main display.
- If the stations alternate intermittently between the station tuned by the EON function and the currently tuned station (“WAITING” flashes in the main display), press EON to cancel the EON function.  
If you do not press the button, the currently tuned station is received finally (“NOT FOUND” appears this time), and the indication of the EON data type flashing on the display disappears.

---

### Description of the PTY codes:

<b>None:</b>	Undefined.
<b>News:</b>	News.
<b>Affairs:</b>	Topical program expanding or enlarging upon the news—debate or analysis.
<b>Info:</b>	Programs the purpose of which is to impart advice in the widest sense.
<b>Sport:</b>	Programs concerned with any aspect of sports.
<b>Educate:</b>	Educational programs.
<b>Drama:</b>	All radio plays and serials.
<b>Culture:</b>	Programs concerning any aspect of national or regional culture, including language, theater, etc.
<b>Science:</b>	Programs about natural sciences and technology.
<b>Varied:</b>	Used for mainly speech-based programs such as quizzes, panel games and personality interviews.
<b>Pop M:</b>	Commercial music of current popular appeal.
<b>Rock M:</b>	Rock music.
<b>Easy M:</b>	Current contemporary music considered to be “easy-listening.”
<b>Light M:</b>	Instrumental music, and vocal or choral works.
<b>Classics:</b>	Performances of major orchestral works, symphonies, chamber music, etc.
<b>Other M:</b>	Music not fitting into any of the other categories.
<b>Weather:</b>	Weather reports and forecasts.

<b>Finance:</b>	Stock market reports, commerce, trading etc.
<b>Children:</b>	Programs targeted at a young audience.
<b>Social:</b>	Programs about sociology, history, geography, psychology and society.
<b>Religion:</b>	Religious programs.
<b>Phone In:</b>	Involving members of the public expressing their views either by phone or at a public forum.
<b>Travel:</b>	Travel information.
<b>Leisure:</b>	Programs about recreational activities.
<b>Jazz:</b>	Jazz music.
<b>Country:</b>	Songs which originate from, or continue the musical tradition of the American Southern States.
<b>Nation M:</b>	Current popular music of the nation or region in that country’s language.
<b>Oldies:</b>	Music from the so-called “golden age” of popular music.
<b>Folk M:</b>	Music which has its roots in the musical culture of a particular nation.
<b>Document:</b>	Programs concerning factual matters, presented in an investigative style.
<b>TEST:</b>	Broadcasts for testing emergency broadcast equipment or receiver.
<b>Alarm!:</b>	Emergency announcement.

**Classification of the PTY codes for some FM stations may be different from the above list.**

# Playing Back CDs (CD/CD-R/CD-RW)

The buttons enlarged in the illustration below are used and explained in this section (pages 24 to 26).

## Remote control

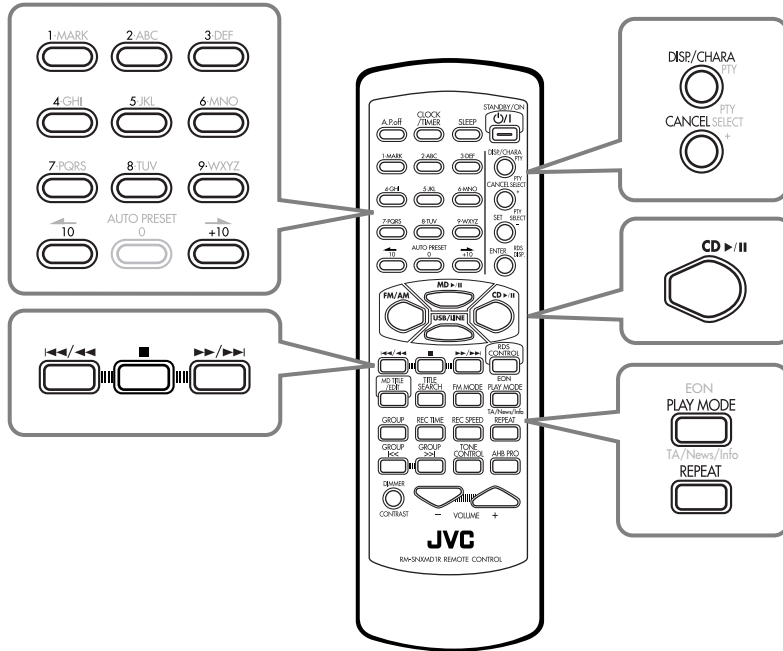

## Front panel

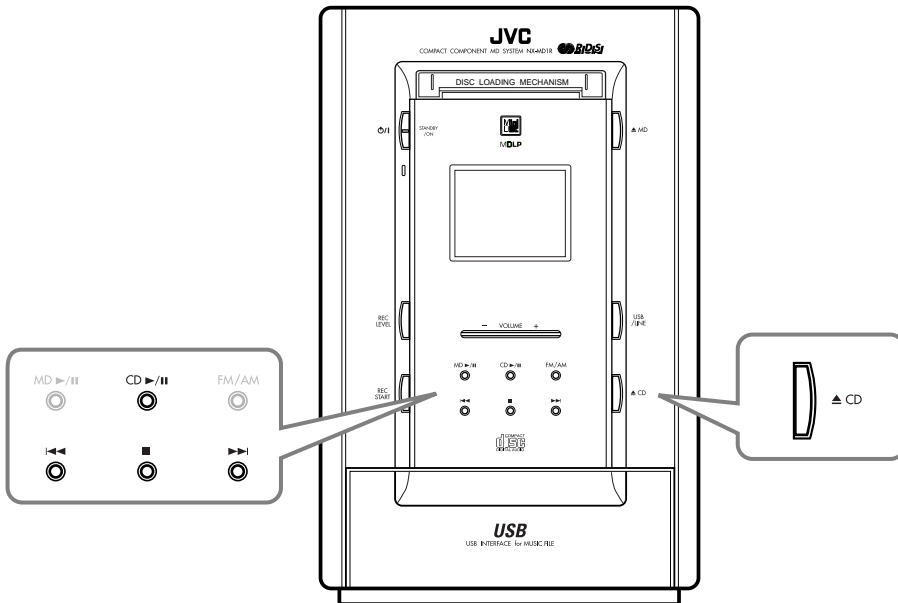

## Precautions on CD Playback

This unit has been designed to play back discs bearing the following logos:



Audio CD



CD Recordable (CD-R)



CD ReWritable (CD-RW)

In addition to the above discs, this unit can play back audio data recorded on CD Text, CD-G (CD Graphics), and CD-Extra.

### When playing a CD-R or CD-RW

User-edited CD-Rs (CD-Recordable) and CD-RWs (CD-ReWritable) can be played back when they are already **“finalized.”** If you play back the **unfinalized** CDs, **“UNFINALIZE”** appears in the main display.

- You can play back your original CD-Rs or CD-RWs recorded in **music CD format ONLY**. (If CD-RWs have been recorded in different format, erase all the data on CD-RWs completely before re-recording on the discs.)



DO NOT play back CD-Rs or CD-RWs recorded the sound files such as MP3.

- Before playing back CD-Rs or CD-RWs, read their instructions or cautions carefully.
- Some CD-Rs or CD-RWs may not be played back on this unit because of their disc characteristics, damage or stain on them, or if the player's lens is dirty.

### Important notices:

- In general, you will have the best performance by keeping your CDs and the mechanism clean.
  - Store CDs in their cases, and keep them in cabinets or on shelves.
  - Keep the unit's CD tray closed when not in use.
- Continuous use of irregular shaped discs (heart-shape, octagonal, etc.) can damage the disc rotating mechanism.



- CD-RWs may require a longer readout time since the reflectance of CD-RWs is lower than for regular CDs.

## Playing Back the Entire CD—Normal Play

### 1 Press **▲ CD** on the unit.

The unit automatically turns on and the CD tray comes out.

- When the source is CD, **“CD OPEN”** appears in the main display.

### 2 Place a CD correctly on the circle of the CD tray, with its label side up.

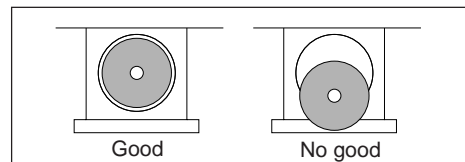
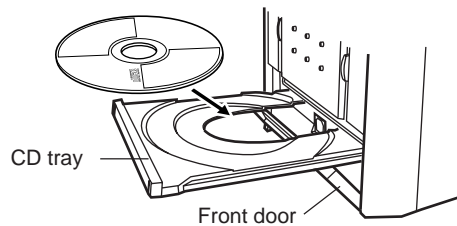

- When using a CD single (8 cm), place it on the inner circle of the CD tray.

### 3 Press **CD ►/II**.

The CD tray closes automatically and the unit starts playing the first track of the CD.

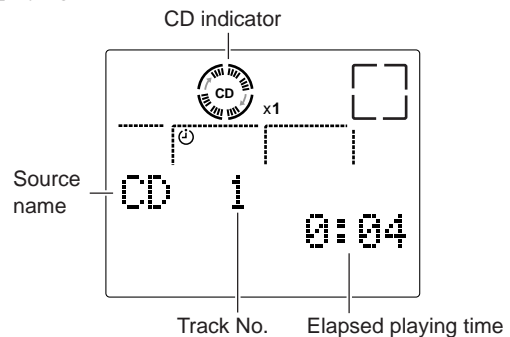

- When you press **▲ CD** instead of **CD ►/II**, the CD tray also closes automatically, but the unit does not start playing.

**To stop during playback**, press **■**.

The total track number and playing time appear in the main display.

**To remove the disc**, press **▲ CD** on the unit.

## Basic CD Operations

While playing a CD, you can do the following operations.

### To stop playback for a moment

Press CD ►/■.

To resume play, press CD ►/■ again.

### To go to another track

Press ►►/►►| or |◀◀/◀◀ (►►| or |◀◀ on the unit) repeatedly.

- ►►/►►| (►►|) : Skips to the beginning of the next or succeeding tracks.
- |◀◀/◀◀ (|◀◀) : Goes back to the beginning of the current or previous tracks.

When CD player is stopped, you can skip or go back to the tracks continuously by pressing and holding the button.

### To go to another track directly using the number buttons

#### On the remote control ONLY:

Pressing the number button(s) allows you to start playing the track number you want.

- Ex.: For track number 5, press 5.  
 For track number 15, press +10, then 5.  
 For track number 20, press +10, then 10.  
 For track number 32, press +10, +10, +10, then 2.

### To locate a particular point in a track during play

Press and hold ►►/►►| or |◀◀/◀◀ (►►| or |◀◀ on the unit).

- ►►/►►| (►►|) : Fast-forwards the tracks.
- |◀◀/◀◀ (|◀◀) : Fast-reverses the tracks.

### To change the information shown in the main display

#### On the remote control ONLY:

Each time you press DISP./CHARA, the information in the main display alternates between the source indication and the clock indication.

#### About CD indicator



Source is  
"CD"



A CD is  
loaded



During  
playback



During  
pause

## Programing the Playing Order of the Tracks —Program Play

You can arrange the order in which the tracks play before you start playing. You can program up to 32 tracks.

#### On the remote control ONLY:

- 1 Load a CD.
- 2 Press CD ►/■, then ■.  
The source is changed to "CD."
- 3 Press PLAY MODE repeatedly until "CD PROGRAM" appears in the main display.  
The PROGRAM indicator also lights up on the display.
  - Each time you press the button, play mode changes as follows:

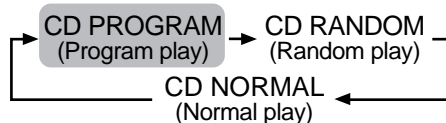

- If a program has been stored in memory, the program is called up.

#### 4 Press the number buttons to select the tracks.

- For how to use the number buttons, see "To go to another track directly using the number buttons" to the left.

CD 5 P 1 — Step No.  
4:12

The current track Total playing time  
Ex. Track No. 5 is selected

#### 5 Repeat step 4 to program other tracks you want.

#### 6 Press CD ►/■.

- The tracks are played in the order you have programmed. Program play ends when all the programmed tracks are played (unless Repeat play is activated).

To stop during play, press ■.

To exit from Program play mode, press PLAY MODE once or twice so that the unit enters another playback mode (Random play or Normal play mode) before or after play.

## To check the program contents

### On the remote control ONLY:

Before playing, you can check the program contents by pressing **⏮/⏪** or **⏭/⏩**.

- **⏮/⏪** : Shows the programmed tracks in the reverse order.
- **⏭/⏩** : Shows them in the programmed order.

## To modify the program

Before playing, you can erase the last programmed track by pressing CANCEL. Each time you press the button, the last programmed track is erased from the program.

**To add tracks in the program before you start play,** simply select track numbers you want to add.

**To erase the entire program,** before or after play, press and hold CANCEL until “CD PROGRAM ALL CLEAR” appears in the main display.

- Turning off the unit or ejecting a CD also erases the entire program.



### **If you try to program a 33rd step**

“MEMORY FULL” will appear in the main display.



### **If your entry is ignored**

You have tried to program a track number that does not exist on the CD (for example, selecting track 14 on a CD that only has 12 tracks). Such entries are ignored.



### **If the total playing time is over “1:39:59”**

The total playing time will not be shown. (“-- : --” will appear.)

## Playing at Random—Random Play

The tracks of a loaded CD will play at random.

### On the remote control ONLY:

#### **1** Load a CD.

#### **2** Press CD **▶/⏮**, then **■**.

The source is changed to “CD.”

#### **3** Press PLAY MODE repeatedly until “CD RANDOM” appears in the main display.

The RANDOM indicator also lights up on the display.

- Each time you press the button, play mode changes as follows:

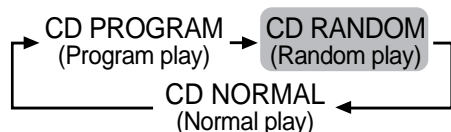

#### **4** Press CD **▶/⏮**.

The tracks are played at random.

Random play ends when all the tracks are played once (unless Repeat play is activated).

**To skip the playing track,** press **⏭/⏩** (or **⏭** on the unit).

- You cannot go back to the previous tracks by pressing **⏮/⏪** (or **⏮** on the unit).

**To stop during playback,** press **■**.

**To exit from Random play mode,** press PLAY MODE once or twice so that the unit enters another playback mode (Normal play or Program play mode) before or after play.

- Pressing one of number buttons also starts Normal play from the selected track.

## Repeating Tracks or CD—Repeat Play

You can have all the tracks, the program or the individual track currently playing repeat as many times as you like.

### On the remote control ONLY:

**To repeat play,** press REPEAT during or before play.

- Each time you press the button, Repeat play mode changes as follows:

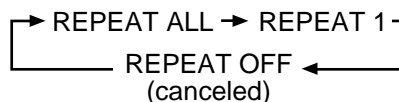

**REPEAT ALL** : Repeats all the tracks on the CD (in Normal play or Random play mode), or all the tracks in the program.

The **↶ ALL** indicator lights up on the display.

**REPEAT 1** : Repeats one track.

The **↶ 1** indicator lights up on the display.

**REPEAT OFF** : Cancels Repeat play.

### **To prohibit disc ejection—Disc Lock**

You can prohibit CD and MD ejection from the unit, and can lock the discs.

See “Prohibiting Disc Ejection—Disc Lock” on page 32 for details.

# Playing Back an MD

The buttons enlarged in the illustration below are used and explained in this section (pages 28 to 32).

## Remote control

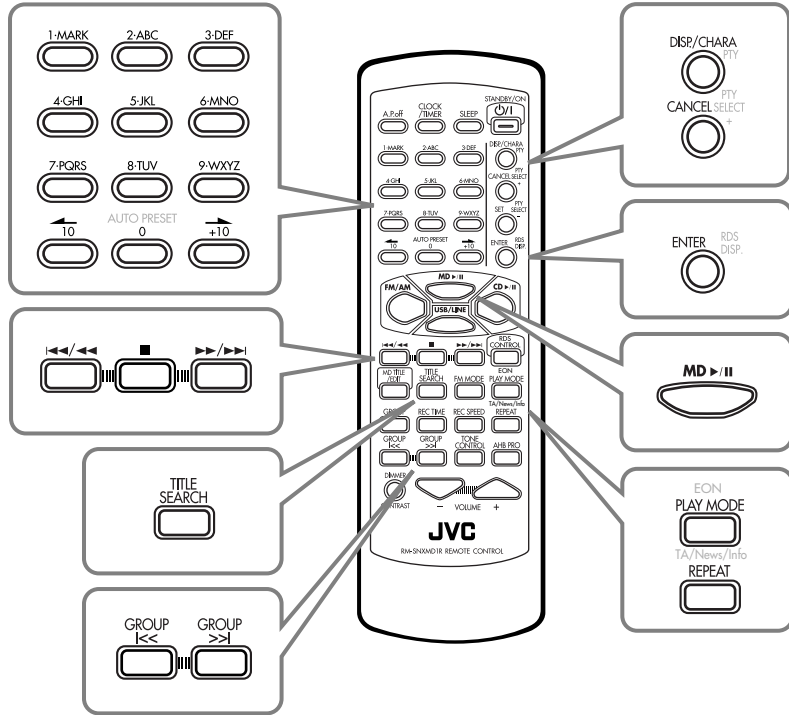

## Front panel

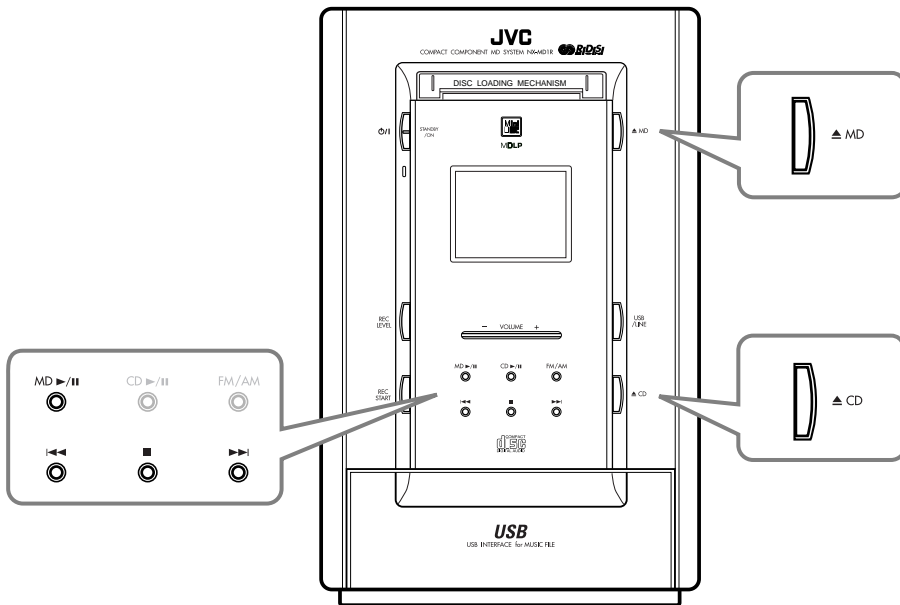



Before inserting an MD, turn on the unit; otherwise, you cannot insert it.

## Playing Back the Entire MD—Normal Play

You can play an MD.

### 1 Insert an MD into the MD loading slot.

The MD is pulled in automatically.

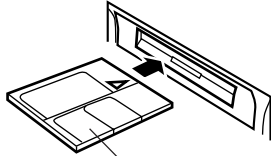

Insert an MD to the same direction as indicated on the MD.

The following indications appear when the current source is "MD"

MD LOADING

MD READING

MD 28 GR. 2  
2:24:08

Total Track No. Total Playing time

\* When the MD has no group, the total group number does not appear.

### 2 Press MD ►/II.

MD playback starts from the first track.

The recording length mode indicator (SP/LP2/LP4)\*\* of the current track lights up on the display.

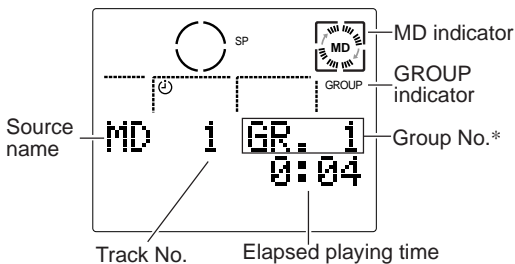

• When the current track does not belong to any group, the group number does not appear.

To stop during play, press ■.

To remove the disc, press ▲ MD.



#### If a track, group or disc has a title

The title will be shown at the bottom portion of the main display. (If a title is long and cannot be shown at a time, the unit scrolls the title to show the entire title.)



#### \*About MD Group

With this unit, you can handle tracks as a group. This is called MD Group function. For details on MD Group function, see page 46.



#### \*\*About recording length mode

MDs are played back in the same recording length mode as they were recorded. When an MD starts playing, the playback mode of the currently playing track lights up on the display.

**SP** : Indicates the tracks recorded in standard stereo recording mode.

**LP2** : Indicates the tracks recorded in 2 times long-hour stereo recording mode.

**LP4** : Indicates the tracks recorded in 4 times long-hour stereo recording mode.

MDLP features a new sound compression method (ATRAC3), and enables a 2 times (or 4 times) long-hour stereo recording and playing.

The MDLP logo is marked on the MD recorders and players compatible with MDLP. It is also marked on MDs pre-recorded in ATRAC3 (excluding recordable MDs).

## Basic MD Operations

While playing an MD, you can do the following operations.

### To stop playback for a moment

Press MD ►/II.

To resume play, press MD ►/II again.

### To go to another track

Press ►►►/►►►I or ◀◀◀/◀◀◀ (►►►I or ◀◀◀ on the unit) repeatedly.

• ►►►/►►►I (►►►I) : Skips to the beginning of the next or succeeding tracks.

• ◀◀◀/◀◀◀ (◀◀◀) : Goes back to the beginning of the current or previous tracks.

When MD recorder is stopped, you can skip or go back to the tracks continuously by pressing and holding the button.

### When the MD has groups:

Press GROUP >>>I or I<<< on the remote control repeatedly.

• GROUP >>>I : Skips to the first track in the next group.

• GROUP I<<< : Goes back to the first track in the current or previous group.

## To go to another track directly using the number buttons

### On the remote control ONLY:

Pressing the number button(s) allows you to start playing the track number you want.

- Ex.: For track number 5, press 5.  
 For track number 15, press +10, then 5.  
 For track number 20, press +10, then 10.  
 For track number 32, press +10, +10, +10, then 2.

## To locate a particular point in a track during play

Press and hold ►►/►►| or |◄◄/◄◄ (►►| or |◄◄ on the unit).

- ►►/►►| (►►|) : Fast-forwards the tracks.
- |◄◄/◄◄ (|◄◄) : Fast-reverses the tracks.

## To change the information shown in the main display

### On the remote control ONLY:

Each time you press DISP./CHARA, the information in the main display changes as follows:

**When you press DISP./CHARA while the track number is shown:**

(Elapsed) playing time and Track title\* →  
 Group title\* → Remaining recording time\*\*\* →  
 Clock indication\*\* → (back to the beginning)

**When you press DISP./CHARA while the total track number is shown:**

Total playing time and Disc title\* → Remaining recording time → Clock indication\*\* → (back to the beginning)

- \* When a track, group or disc has no title, "NO TITLE" appears. If the current track does not belong to any groups, "UNGROUP TRK" will appear.
- \*\* "0:00" flashes in the main display, before you set the built-in clock (see page 11).
- \*\*\* During playback, this indication is skipped.

### About MD indicator



Source is "MD"



An MD is loaded



During playback



During pause

## Playing Tracks in a Group—Group Play

You can play back tracks in a group.

- To make a group or edit groups, see pages 45 to 54.

### On the remote control ONLY:

**1** Load an MD including a group(s).

**2** Press MD ►/||, then ■.

The source is changed to "MD."

MD 28 GR. 2 — Total Group No.  
 2:24:08

- When the loaded MD has no group, the total group number does not appear in the main display.

**3** Press PLAY MODE repeatedly until "MD GROUP" appears in the main display.

The GR. indicator also lights up on the display.

- Each time you press the button, play mode changes as follows:

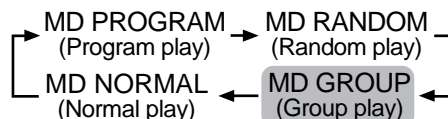

**4** Press GROUP >>| or |<< to select a group.

- GROUP >>| : Selects group numbers in the increasing order.
- GROUP |<< : Selects group numbers in the decreasing order.

MD 11 GR. 2 — Group No.  
 4:26

The first track No. of Group 2  
 EX. Group 2 is selected.

**5** Press MD ►/||.

The tracks in the selected group are played.

Group play ends when all the tracks in the selected group are played back.

**To go to another track in the same group, press ►►/►►| or |◄◄/◄◄ (►►| or |◄◄ on the unit) repeatedly.**

- ►►/►►| (►►|) : Skips to the beginning of the next or succeeding tracks.
- |◄◄/◄◄ (|◄◄) : Goes back to the beginning of the current or previous tracks.

**To go to another group, press GROUP >>| or |<< on the remote control repeatedly.**

- GROUP >>| : Skips to the first track in the next group.
- GROUP |<< : Goes back to the first track in the current or previous group.

To stop during play, press ■.

To exit from Group play mode, press PLAY MODE repeatedly so that the unit enters another playback mode (Normal play, Program play or Random play mode) before or after play.

- Pressing one of number buttons also starts Normal play from the selected track.

## Programming the Playing Order of the Tracks —Program Play

You can arrange the order in which the tracks play before you start playing. You can program up to 32 tracks.

**On the remote control ONLY:**

**1** Load an MD.

**2** Press MD ►/II, then ■.

The source is changed to “MD.”

**3** Press PLAY MODE repeatedly until “MD PROGRAM” appears in the main display.

The PROGRAM indicator also lights up on the display.

- Each time you press the button, play mode changes as follows:

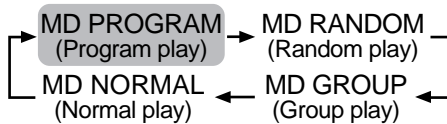

- If a program has been stored in memory, the program is called up.

**4** Press the number buttons to select the tracks.

- For how to use the number buttons, see “To go to another track directly using the number buttons” on page 29.

MD	5	P	1	— Step No.
		4	12	
		Total playing time		
	Ex. Track No. 5 is selected			

**5** Repeat step 4 to program other tracks you want.

**6** Press MD ►/II.

The tracks are played in the order you have programmed. Program play ends when all the programmed tracks are played (unless Repeat play is activated).

To stop during play, press ■.

To exit from Program play mode, press PLAY MODE repeatedly so that the unit enters another playback mode (Random play, Group play, or Normal play mode) before or after play.

**To check the program contents**

**On the remote control ONLY:**

Before playing, you can check the program contents by pressing ◀◀/◀◀ or ▶▶/▶▶.

- ◀◀/◀◀ : Shows the programmed tracks in the reverse order.
- ▶▶/▶▶ : Shows them in the programmed order.

**To modify the program**

Before playing, you can erase the last programmed track by pressing CANCEL. Each time you press the button, the last programmed track is erased from the program.

**To add tracks in the program before you start play,** simply select track numbers you want to add.

**To erase the entire program,** before or after play, press and hold CANCEL until “MD PROGRAM ALL CLEAR” appears in the main display.

- Turning off the unit or ejecting a disc also erases the entire program.



**If you try to program a 33rd step**  
“MEMORY FULL” will appear in the main display.



**If your entry is ignored**  
You have tried to program a track number that does not exist on the MD (for example, selecting track 14 on an MD that only has 12 tracks). Such entries are ignored.



**If the total playing time is over “2:29:59”**  
The total playing time will not be shown. (“-- : --” will appear.)

---

## Playing at Random—Random Play

---

The tracks of a loaded MD will play at random.

### On the remote control ONLY:

**1** Load an MD.

**2** Press MD ►/II, then ■.

The source is changed to “MD.”

**3** Press PLAY MODE repeatedly until “MD RANDOM” appears in the main display.

The RANDOM indicator also lights up on the display.

- Each time you press the button, play mode changes as follows:

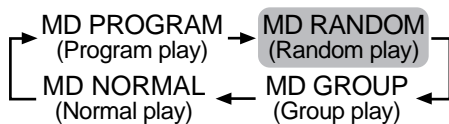

**4** Press MD ►/II.

The tracks are played at random.

Random play ends when all the tracks are played once (unless Repeat play is activated).

**To skip the playing track,** press ►►/►►I (or ►►I on the unit).

- You cannot go back to the previous tracks by pressing I◀◀/◀◀ (or I◀◀ on the unit).

**To stop during play,** press ■.

**To exit from Random play mode,** press PLAY MODE once or twice so that the unit enters another playback mode (Group play, Normal play, or Program play mode) before or after play.

- Pressing one of number buttons also starts Normal play from the selected track.

---

## Repeating Tracks or MD—Repeat Play

---

You can have all the tracks, the program, the individual track or group currently playing repeat as many times as you like.

### On the remote control ONLY:

**To repeat play,** press REPEAT during or before play.

- Each time you press the button, Repeat play mode changes as follows:

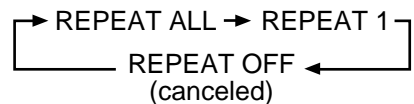

**REPEAT ALL** : Repeats all the tracks on the MD (in Normal play or Random play mode) or all the tracks in the program or in the group.

The ◀ ALL indicator lights up on the display.

**REPEAT 1** : Repeats one track.

The ◀ indicator lights up on the display.

**REPEAT OFF** : Cancels Repeat play.

---

## Searching Tracks to Play—MD Title Search

---

You can search for the tracks by their titles and play back them.

For details on assigning a title, see page 61.

### On the remote control ONLY:

**1** Load an MD.

**2** Press MD ►/II, then ■.

The source is changed to “MD.”

**3** Press TITLE SEARCH.

The TITLE SEARCH indicator lights up on the display. Play mode changes to Normal play and the playback ends.

“TITLE” and the character entry indication appear in the main display.

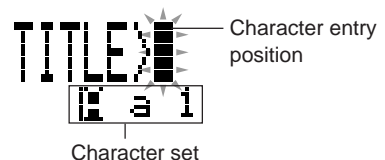

## 4 Input character(s) to search for the track title.

You can input up to 5 characters. The unit will search for the tracks which have the input characters at the head of their titles.

- You can also search for the tracks without a title. In this case, go to step 5.

### 1) Press DISP/CHARA to select the character set you want.

Each time you press the button, the character sets change as follows:

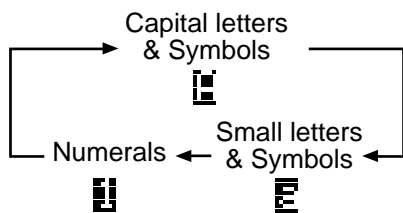

### 2) Press the character entry button for a character you want to input.

Examples:

- To input an “A” or “a,” press ABC once.  
To input a “B” or “b,” press ABC twice.  
To input a “C” or “c,” press ABC three times.
- To input a symbol, press MARK repeatedly until the mark you want appears.
- To input a numeral, press 0 – 9.
- To enter a space while entering a title, press → twice.
- To move the character entry position while entering a title, press → or ←.
- If you have entered an incorrect character, press CANCEL to cancel the last entry.

### 3) Repeat steps 4 – 1) and 4 – 2) to input other characters.

- If the character you want to input next is assigned to the same button you have just pressed in step 4 – 2), press → first to move the character entry position to the right.

## 5 Press ENTER.

“SEARCH” flashes in the main display. The unit starts searching for the track.

- When the track with the desired title is found, the unit plays back the track. (After the track is played, the unit starts searching for the next track.)
- If no track with the desired title is found, “SEARCH END” appears in the main display and Normal play mode resumes.

To skip the current playback and search for the next track, press ►►/►►.

To cancel title searching, press TITLE SEARCH.

When you press the button during playback, Normal play resumes.



Available Symbols are as follows:

(Blank)	!	"	#	\$	%	&	'	( )
*	+	,	-	.	/	:	;	< =
>	?	@	_	\				

## Prohibiting Disc Ejection—Disc Lock

You can prohibit CD and MD ejection from the unit and can lock discs.

### On the unit ONLY:

#### To prohibit disc ejection

1 Press and hold ■ when the unit is in standby mode.

2 Press ▲ CD.

“LOCKED” appears for a while, and the loaded discs (both CD and MD) are locked.

3 Release your finger from ■.



If you try to eject the locked discs

“LOCKED” appears to inform you that the Disc Lock is in use.

To cancel the prohibition and unlock the discs, repeat the above procedure.

“UNLOCKED” appears for a while in step 2, and the loaded discs (both CD and MD) are unlocked.

# Playing Back PC and Changing the Source Name

The buttons enlarged in the illustration below are used and explained in this section (pages 34 to 36).

## Remote control

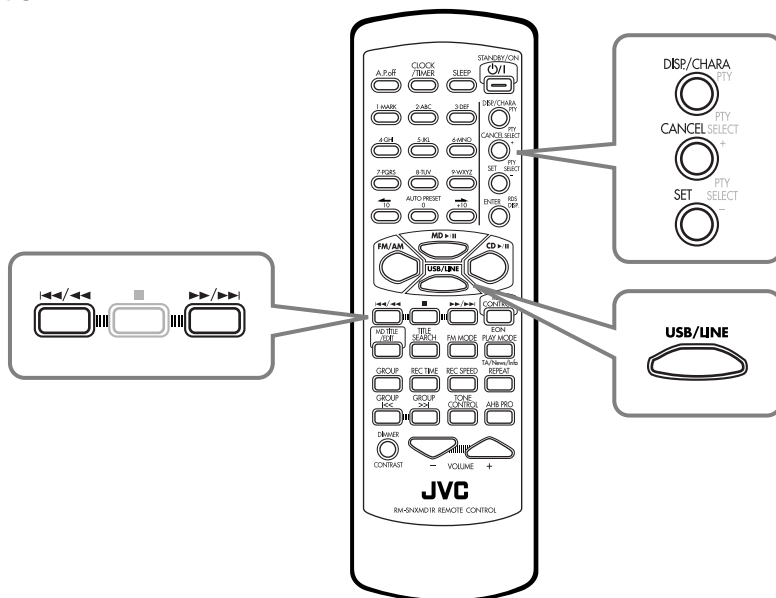

## Front panel

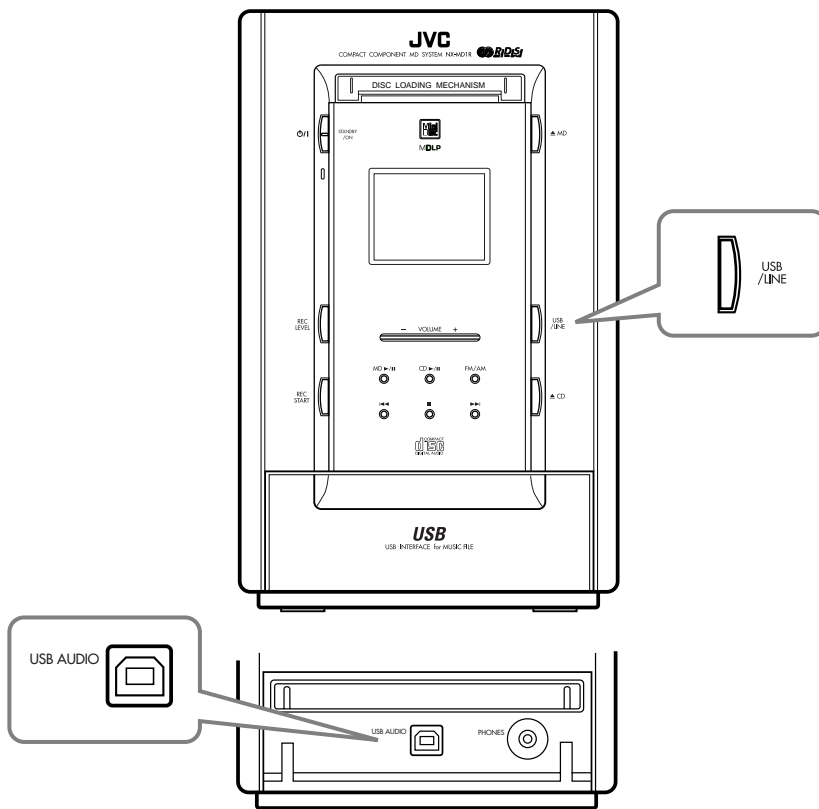

## Playing Back PC Sound Files

**When you connect the PC for the first time, see “Installing USB Drivers” on page 35.**

This unit is equipped with a USB AUDIO terminal inside the front panel. You can connect the PC to this terminal and enjoy sound reproduced through the PC.

- You cannot record the sounds from the PC through a USB AUDIO terminal.

### 1 Press USB/LINE repeatedly to select “USB (or PC\*)”.

The unit automatically turns on and the source name selected previously appears in the main display.

- Each time you press the button, the source changes as follows:



\* If you have changed the source name, the changed name will appear. (See page 36.)

### 2 Turn on your PC.

### 3 Connect the PC to USB AUDIO terminal inside the front door using a USB cable (not supplied).

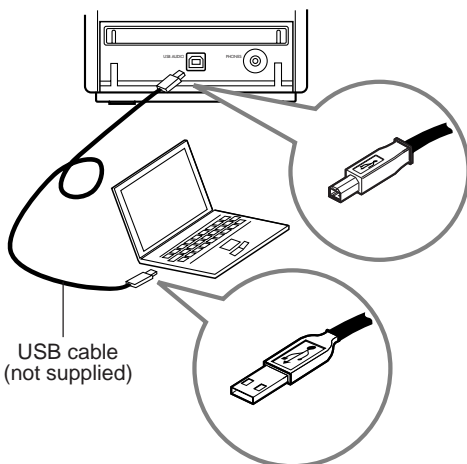

### 4 Confirm the PC recognizes the unit.

Once the PC recognizes the unit, you can use the PC as an playback source from now on simply by connecting a USB cable while both the PC and the unit are turned on—“Plug and Play.”

- If the PC does not recognize the unit, disconnect the USB cable and connect it again. If this does not work, restart the PC.

### 5 Play back the sound file with the appropriate application software installed on the PC.

The sounds come in from the PC through the USB cable.

- See the manuals supplied with the PC and the application software.
- If you turn off the unit (on standby) while the sounds come in from the PC, “plug and play” will not work next time. In this case, repeat this procedure from step 1.
- If no sounds come in from the PC, see “Installing USB Drivers” on the page 35.

### 6 Adjust the volume and sound on the unit.

**To disconnect the USB cable while the sounds come in from PC, stop playing back the sound file on the PC, then disconnect the cable.**



**DO NOT** disconnect the USB cable while the sounds come from the PC.

### To change the information shown in the main display

#### **On the remote control ONLY:**

Each time you press DISP/CHARA, the information in the main display alternates between the source indication and the clock indication.

## Installing USB Drivers

When you connect the PC for the first time, follow the procedure below.

### Before installing

- Check if your PC equipped with the CD-ROM drive is running on Windows® 98\*, Windows® Me\*, or Windows® 2000\*, and prepare its CD-ROM.
- Check your PC's BIOS setting—whether USB is available, and whether USB IRQ is set to “AUTO” or to available IRQ number.

The following procedure is described using the English version of Windows® 98. If your PC is running on a different version of Windows, the screens shown on your PC's monitor will differ from the ones used in the following procedure.

### General notes

- Use a full speed USB cable (revision 1.0).
- The drivers installed can be recognized only when the USB cable is connected between the unit and your PC.
- The sound may not be played back correctly—interrupted or degraded—due to your PC settings and PC specifications.

### 1 Turn on your PC and start running Windows® 98, Windows® Me or Windows® 2000.

If the PC has been turned on, quit all the applications now running.

### 2 Press USB/LINE on this unit to select “USB.”

- If you have changed the source name of USB, select “PC.” (See page 36.)

### 3 Connect the PC to the unit using a USB cable (not supplied).

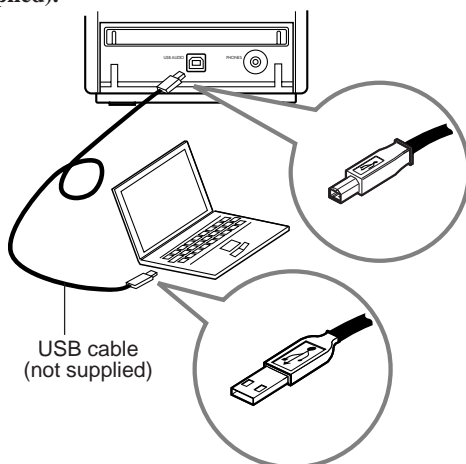

Your PC automatically recognizes this connection, and shows the following screen on the monitor.



### 4 Install the USB drivers following the instructions on the PC's monitor.

### 5 Check if the drivers are correctly installed.

1. Open the Control Panel on your PC: Select [Start] → [Settings] → [Control Panel].
2. Click [System] → [Device Manager] → [Sound, video and game controllers] and [Universal Serial Bus controllers].

The following window appears, and you can check whether the drivers (“USB Audio Device” and “USB Composite Device”) are installed.

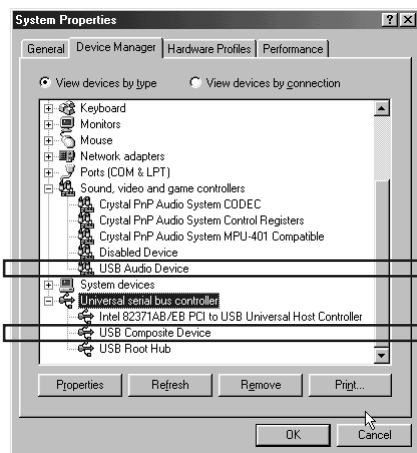

- The items shown on the PC's monitor differ depending on your PC settings.



## 6 Change the PC audio setting.

1. If you have closed Control Panel, open it again:  
Select [Start] → [Settings] → [Control Panel].
2. Click [Multimedia Properties], then select “USB Audio Device [1]” for “Playback” of “Audio,” and close the window.
3. Open the Volume control on your PC: Select [Start] → [Program] → [Accessory] → [Entertainment] → [Volume control].
4. Set the volume appropriately and remove the check mark in the box at “Mute.”

Now your PC is ready for playback through the USB connection.

After installation is completed, you can use your PC as the playback source. The PC automatically recognizes the unit whenever a USB cable is connected to the PC and the unit while the unit is turned on.

- When not using the PC as the playback source, disconnect the USB cable.

\* Microsoft®, Windows® 98, Windows® Me and Windows® 2000 are registered trademarks of Microsoft Corporation.

## Changing the Source Name

You can change the source names—USB, LINE, and DIGITAL IN—according to the equipment connected to the unit.

- You cannot change the source names while recording.

### On the remote control ONLY:

#### 1 Press USB/LINE repeatedly to select the source you want to change.

The unit automatically turns on and the source name selected previously appears in the main display.

- Each time you press the button, the source changes as follows:



#### 2 Press and hold USB/LINE until “NAME CHANGE” appears in the main display.

The selected source name starts flashing in the main display.

NAME CHANGE  
U S B  
OK? SET

EX. “USB” is selected

#### 3 Press ►►/►►| or |◀◀/◀◀ to select the new source name.

- When “USB” is selected in step 1  
Each time you press the button, the source name alternates between “USB” and “PC.”
- When “LINE” is selected in step 1  
Each time you press the button, the source name changes as follows:

LINE ⇄ TAPE ⇄ DBS ⇄ VCR ⇄ TV ⇄  
GAME ⇄ (back to the beginning)

- When “DIGITAL IN” is selected in step 1  
Each time you press the button, the source name alternates between “DIGITAL IN” and “DBS-DIGITAL.”
- To cancel the setting, press CANCEL.

#### 4 Press SET to finish changing the source name.

- The selected source name appears in the main display.

# Recording on MDs

The buttons enlarged in the illustration below are used and explained in this section (pages 38 to 44).

## Front panel

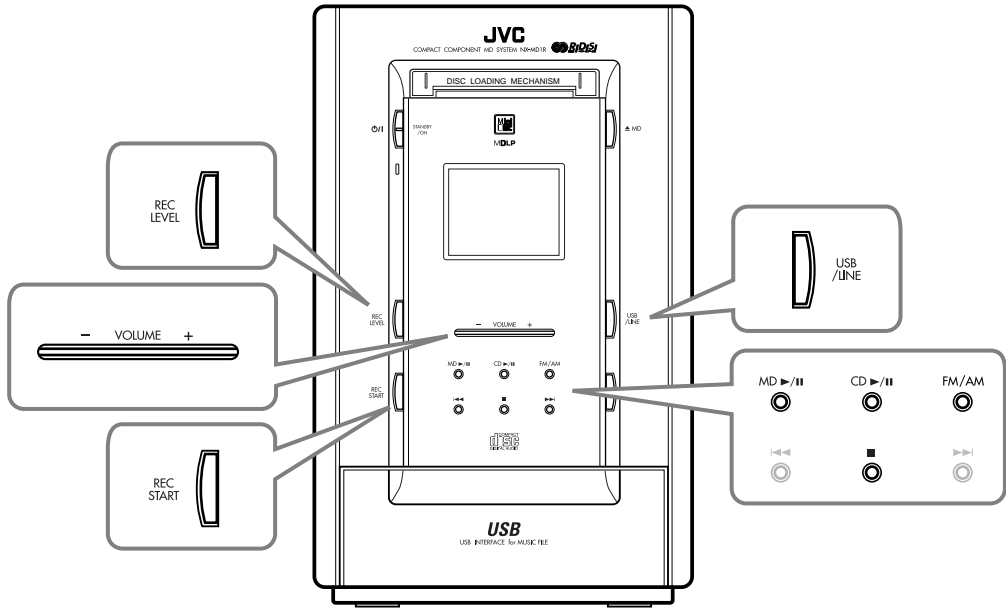

## Remote control

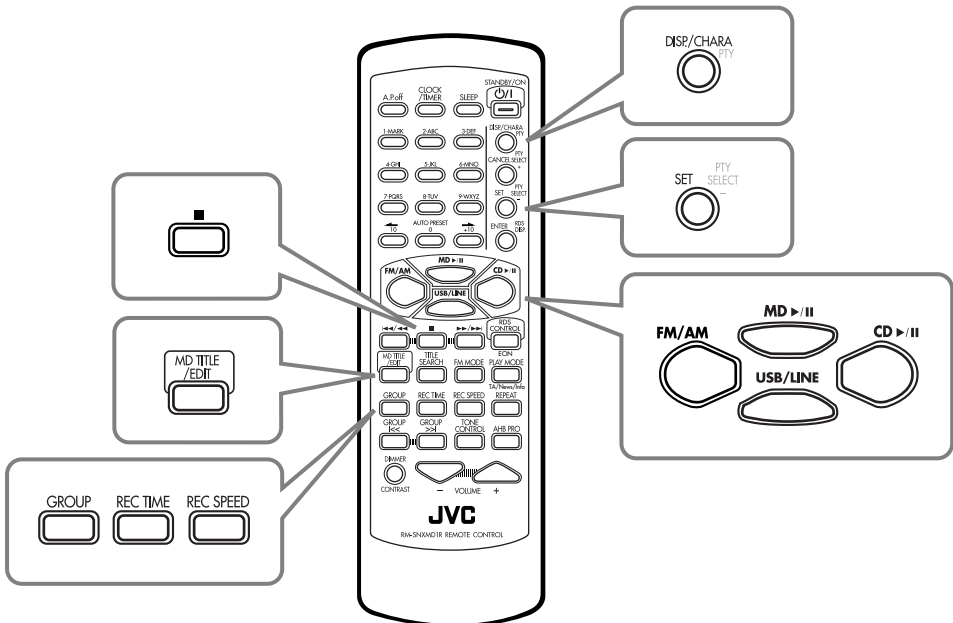

## Before You Start Recording

- **It may be unlawful to record or play back copyrighted material without the consent of the copyright owner.**
- The sampling frequency rate converter built in the MD recorder allows you to record a digital source if its sampling frequency is 32 kHz, 44.1 kHz, or 48 kHz. If no source equipment is connected to the OPTICAL DIGITAL IN terminal or if the sampling frequency of the connected equipment is not 32 kHz, 44.1 kHz, or 48 kHz, “UNLOCK” appears in the main display (no recording is possible).
- You cannot record the following sounds: Dolby Digital, DTS Digital Surround, or MPEG Audio signals (through the OPTICAL DIGITAL IN terminal); the sound signals from the PC (through the USB AUDIO terminal).
- When you record onto a partially recorded MD, its contents are not erased or overwritten. The recording starts from the point following the last recorded track of the MD. If you want to record on such an MD from the beginning, you have to erase its contents first (see “Erasing All Tracks—ALL ERASE” on page 59).
- When an MD is fully recorded, recording stops automatically.
- You can adjust the recording level when the source is CD, LINE\* or DIGITAL IN\*. When the source is FM/AM, the recording level is automatically set correctly.
  - \* If you have changed the source names, the changed names will appear in the main display.
- The recording level is not affected by the volume. During recording you can adjust the volume you are actually listening to without affecting the recording level.
- While recording, you can hear the Active Hyper Bass Pro and/or the tone control effect through the speakers or headphones. However, the playback sound is recorded without these effects (see page 15).

### About the track marks

When playing an MD, you can move among the tracks. You can do this because there is a mark recorded at the beginning of each track enabling you to locate the track. This mark is called a “**track mark**” and the portion between two adjacent track marks is called a “**track**.”

- **When using CD synchronized recording:**  
A track mark is recorded automatically at the beginning of each track. You cannot put a track mark manually.
- **When recording from an analog source—FM, AM(MW/LW), and external component connected to the LINE IN jacks:**  
No track mark is recorded on a disc. This means that, when playing this disc, an MD recorder will regard the entire recording as one track. However, if there is a blank of 3 seconds or more, the unit will consider it as a blank separating 2 tracks and consequently put a track mark.
- **When recording through the OPTICAL DIGITAL IN terminal:**
  - If the playback source DOES have track marks recorded, they are recorded automatically at the points where the tracks change.
  - If the playback source DOES NOT have track marks recorded, this unit functions in the same way for recording an analog source.

**To put a track mark manually (except when using CD synchronized recording),** press SET on the remote control at the place you want to put a track mark.

**To add a track mark after recording is over,** you can use the DIVIDE function (see page 56).

### To avoid erasing important recordings

The recordable MD has an erasure prevention tab so that important recordings are not accidentally erased. When you finish recording or editing, slide to open the erasure prevention tab on the cartridge side surface. New recording or editing is now no longer possible. (If you try to do, “DISC PROTECTED” appears in the main display.) To do re-recording or editing, return the tab to the closed position.

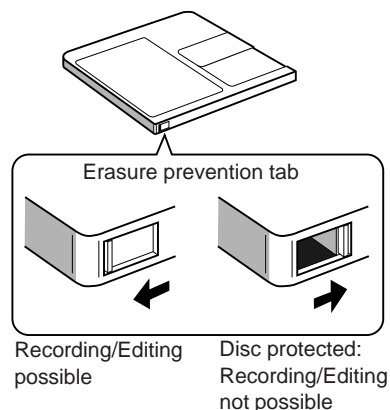

**If “PLAYBACK DISC” appears in the main display when you try to record on an MD**  
The MD is only for playback use, not for recording.

## Stereo Long-Hour Recording (MDLP)

On conventional MD recorders, 2 times long-hour recording on MDs has been possible only in monaural sound, but this unit allows for 2 times or 4 times long-hour recording without losing stereo sound.

This feature can be used for any recording method provided with this unit.

Songs (tracks) can be recorded on a single MD using different recording length modes—SP: Standard Play, LP2: 2 Times Long Play, LP4: 4 Times Long Play.

**SP** : Signifies standard-hour stereo recording. The number of hours usable for recording is the same as shown on the package of the MD.

**LP2** : Signifies 2 times long-hour stereo recording. The number of hours usable for recording is twice as long as shown on the package of the MD.

**LP4** : Signifies 4 times long-hour stereo recording. The number of hours usable for recording is 4 times as long as shown on the package of the MD.

### REMEMBER to check the remaining recording time of MDs before starting recording

The remaining recording time of MDs will be calculated and shown, based on the recording length mode (SP/LP2/LP4) currently selected.

Before starting recording or using the Recording Timer, check the recording time remaining on the MD for each recording length mode (SP/LP2/LP4) and select the optimum recording length mode.

#### To check the remaining recording time

- 1 Insert an MD to record on.
- 2 Press MD ►/II, then ■ to select “MD” as the source.
- 3 Press REC TIME on the remote control to select the desired recording length mode (SP/LP2/LP4).
- 4 Press DISP/CHARA on the remote control repeatedly until the remaining recording time (“REM”) is shown in the main display.

## Precautions for performing long-hour stereo recording

After having made long-hour stereo recordings on this unit, pay attention to the following:

- Songs (tracks) recorded in 2 times or 4 times long-hour recording mode can only be played back on the equipment provided with MDLP, compatible with a long-hour stereo recording function.
- “LP:” is assigned before a title automatically. This indication is shown only when you play the tracks recorded with MDLP using MDLP-incompatible equipment. In this case, the playback proceeds without sounds.
- When editing songs (tracks) on an MD, you cannot join (JOIN) songs (tracks) recorded in different recording length modes (SP/LP2/LP4).

### To cancel assigning “LP:” to a title

As long as you record on and play back MDs using this unit or MDLP-compatible equipment, it is not necessary for you to assign “LP:” to a title.

You can record the sound in long-hour stereo recording mode (LP2/LP4) without assigning “LP:.”

### On the remote control ONLY:

Press and hold MD TITLE/EDIT while the unit is turned on until “(LP:) OFF” appears in the main display.

**To resume assigning “LP:” to a title**, press and hold MD TITLE/EDIT while the unit is on until “(LP:) ON” appears in the main display.



#### More about MDLP

- You cannot make a long-hour monaural recording using this unit.
- Sound quality will decrease as the recording length mode changes to LP2 (a little) and LP4 (much). To obtain the best sound quality, it is recommended to use the SP mode when recording.

### About High-Speed Recording

There are some restrictions to observe for high-speed recording (x2 speed recording: two times as quick as normal speed recording, x4 speed recording: four times as quick as normal speed recording) to protect copyrights. (HCMS: see page 70.)

This unit is so designed that a song (track) recorded from the built in CD player using high-speed recording cannot be re-recorded until 74 minutes elapse after the previous recording started.

If you try to re-record the same song (track) within the 74 minutes, recording is canceled and “HCMS CANNOT COPY” appears as a warning.

HCMS CANNOT  
COPY  
about 65min

The remaining time required until re-recording will then appear in the main display.

If this happens, press  after the remaining time appears.

REMEMBER if you are trying to record a program or the repeated playback including the same song (track) twice using high-speed recording, recording will stop at the beginning of the 2nd recording of the same song (track). (“HCMS CANNOT COPY” will appear in the main display.)



#### During high-speed recording

You cannot listen to any source, and therefore, cannot adjust the volume level. (“CANNOT LISTEN!” will appear if you try to do.)



#### About x4 speed recording

- You can select the x4 speed recording only when you select SP as the recording length mode.
- When you select the x4 speed recording, you cannot record using Program or Random play mode.

### Adjusting the Recording Level for CD

You can adjust the recording level only when you select “x1 SPEED” as the recording speed.

- 1 Load a CD you want to record.
- 2 Press CD  to start playback.
- 3 Press REC SPEED on the remote control to select “x1 SPEED.”  
The x1 indicator lights up on the display.
- 4 Press REC LEVEL on the unit.  
The recording level indication appears in the main display.
 

REC LEVEL  
0dB  
ADJUST VOL.

  - If “x1 SPEED” is not selected, “CANNOT ADJUST REC LEVEL” appears in the main display.
- 5 Press VOLUME + or – on the unit repeatedly to adjust the recording level from –12 dB to +12 dB by 2 dB steps.
  - To decrease the level, press VOLUME – .
  - To increase the level, press VOLUME + .
- 6 Press REC LEVEL on the unit to finish adjusting the recording level.
- 7 Press .



#### The recording level will be reset to “0 dB (initial setting)” when

- Finishing the recording
- Changing the recording speed (x1/x2/x4)
- Changing the source
- Ejecting MD or CD
- Turning off the unit (on standby)

### Adjusting the Recording Level

You can adjust the recording level when CD or the equipment connected to LINE IN jacks or OPTICAL DIGITAL IN terminal is selected as the source.

When the recording level is too high, “Level OVER!” appears in the main display and the OVER indicator lights up on the display.

- You cannot adjust the recording level when the source is FM/AM (MW/LW).

## Adjusting the recording level for LINE

### 1 Press USB/LINE repeatedly to select “LINE.”

- If you have changed the source names, the changed names will appear in the main display.

### 2 Start playback on the external equipment connected to the LINE IN jacks.

### 3 Press REC LEVEL on the unit.

The recording level indication appears and the current level flashes in the main display.



LINE INPUT  
LEVEL 1  
ADJUST VOL.

### 4 Select “LEVEL 1” or “LEVEL 2.”

- To select “LEVEL 1,” press VOLUME – .
- To select “LEVEL 2,” press VOLUME + .

#### LEVEL 1:

Select this when the recording level is low.

#### LEVEL 2:

Select this when the input sound is distorted.

- The setting of the recording level remains in a memory even though the unit is turned off.

### 5 Press REC LEVEL on the unit to finish adjusting the recording level.

### 6 Stop playback on the external equipment.

## Adjusting the recording level for DIGITAL IN

There are two modes for adjusting the recording level—“AUTO MODE” and “MANUAL MODE.”

**AUTO MODE** : The unit decreases the level by 2 dB steps automatically each time the OVER indicator lights up on the display.

**MANUAL MODE** : You can adjust the level manually.

### 1 Press USB/LINE repeatedly to select “DIGITAL IN.”

- If you have changed the source names, the changed names will appear in the main display.

### 2 Start playback on the external equipment connected to the OPTICAL DIGITAL IN terminal.

### 3 Press REC LEVEL on the unit.

The mode selecting indication appears and the current mode flashes in the main display.



AUTO MODE  
MANUAL MODE  
ADJUST VOL.

### 4 Select “AUTO MODE” or “MANUAL MODE.”

- To select “AUTO MODE,” press VOLUME + .
- To select “MANUAL MODE,” press VOLUME – .

When you select “AUTO MODE,” go to step 7.

### 5 Press REC LEVEL on the unit.

The recording level indication appears in the main display.



REC LEVEL  
0dB  
ADJUST VOL.

### 6 Press VOLUME + or – on the unit repeatedly to adjust the recording level from –12 dB to +12 dB by 2 dB steps.

- To decrease the level, press VOLUME – .
- To increase the level, press VOLUME + .

### 7 Press REC LEVEL on the unit to finish adjusting the recording level.

### 8 Stop playback on the external equipment.



The recording level will be reset to “0 dB (initial setting)” when

- Pressing ■ to stop the recording
- Changing the source
- Ejecting MD
- Turning off the unit (on standby)

## Setting Group Recording Function

If you record any source with the GROUP indicator lit, all tracks recorded at a time are allocated to one group.

**You can activate or deactivate the function only when an MD is loaded on the unit.**

For details on the group, see page 46.

### On the remote control ONLY:

To activate this function, press GROUP.

“GROUP ON” appears in the main display and the GROUP indicator lights up on the display.



GROUP ON

To deactivate this function, press GROUP. "GROUP OFF" appears in the main display and the GROUP indicator goes off from the display.

# GROUP OFF

## Recording CDs—CD Synchronized Recording

Using the synchronized recording methods, you can start and stop CD play and MD recording at the same time.

- If you want to adjust the recording level, see page 40.

When you do not want to use Group recording function, press GROUP on the remote control to turn off the GROUP indicator on the display.

You can assign the titles during recording. For details, see page 60.

**1** Insert a recordable MD into the MD loading slot while the unit is turned on.

**2** Prepare a CD.

- Press CD ►/II, then press ■ after loading a CD.
- You can make a program (see page 25) or select Random play mode (see page 26) if you want. In this case, do not start playing CD.

**3** Press REC TIME on the remote control to select the recording length mode.

- Each time you press the button, the recording length mode changes as follows:

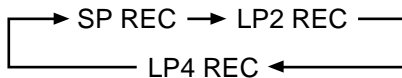

The indicator corresponding to the selected recording length mode lights up on the display.

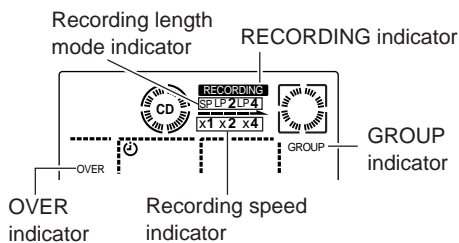

- For the recording length mode, see "Stereo Long-Hour Recording (MDLP)" on page 39.
- If you want to select "x4 SPEED" recording, select "SP."

**4** Press REC SPEED on the remote control to select the recording speed.

- Each time you press the button, the recording speed changes as follows:

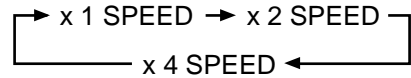

The indicator corresponding to the selected recording speed lights up on the display.

- If you want to record using Program or Random play mode, select "x1 SPEED" or "x2 SPEED."
- You can adjust the recording level only when "x1 SPEED" is selected.

**5** Press REC START on the unit.

The RECORDING indicator lights up on the display and the recording starts.

After the recording ends, both the CD player and the MD recorder stop automatically.

To stop recording, press ■.

"WRITING" flashes for a while. Both the CD player and the MD recorder stop automatically.

**To record a single track during playback**

Press REC START on the unit while the desired track on the CD is played back (regardless of the play mode). The playback of that CD track stops, and the same track starts playing back from the beginning again. Then, the recording starts.

After the recording, both the CD player and the MD recorder stop automatically.

**To change the information shown in the main display while recording**

**On the remote control ONLY:**

Each time you press DISP/CHARA, the information in the main display changes as follows:

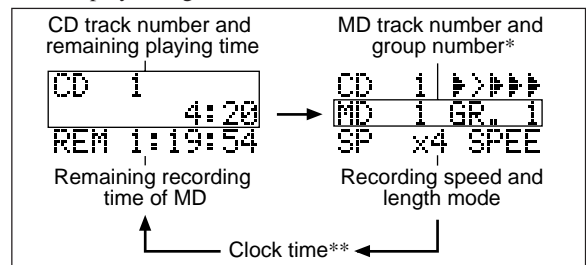

\* When Group recording is activated.

\*\* "0:00" flashes in the main display, before you set the built-in clock (see page 11).



### About “x4 SPEED” speed recording

If you try to record with “x4 SPEED” using Program or Random play mode, “CD PROGRAM CANNOT x4 RECORDING!” or “CD RANDOM CANNOT x4 RECORDING!” appears in the main display.

## Recording FM/AM (MW/LW) Broadcasts

When you do not want to use Group recording function, press GROUP on the remote control to turn off the GROUP indicator on the display.

- 1 Insert a recordable MD into the MD loading slot while the unit is turned on.**
- 2 Tune into a station you want.**
  - For details, see pages 17 and 18.
  - You cannot adjust the recording level.
- 3 Press REC TIME on the remote control to select the recording length mode.**
  - Each time you press the button, the recording length mode changes as follows:

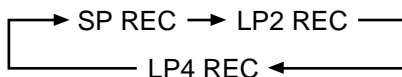

The indicator corresponding to the selected recording length mode lights up on the display.

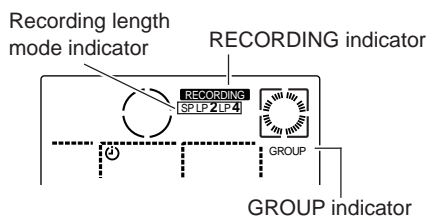

- For the recording length mode, see “Stereo Long-Hour Recording (MDLP)” on page 39.

- 4 Press REC START on the unit.** The RECORDING indicator lights up and “REC START” appears in the main display, then the recording starts.

To stop recording, press ■. “WRITING” flashes for a while.

## To change the information shown in the main display while recording

### On the remote control ONLY:

Each time you press DISP./CHARA, the information in the main display changes as follows:

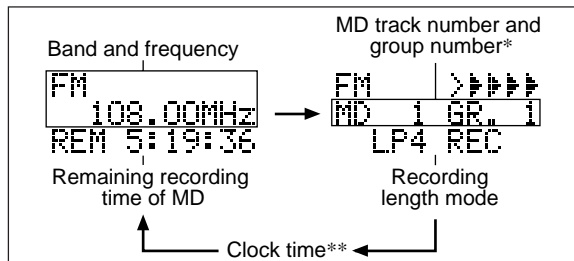

\* When Group recording is activated.

\*\* “0:00” flashes in the main display, before you set the built-in clock (see page 11).

## To put a track mark manually while recording

### On the remote control ONLY:

Press SET at the place you want to put a track mark. “TRK MARKING” appears in the main display for a while.

- For details, see “About the track marks” on page 38.

## Recording the External Equipment—Sound Synchronized Recording

With this recording method, you can start recording automatically when the source sound comes into this unit through the LINE IN jacks or the OPTICAL DIGITAL IN terminal.

Sound Synchronized Recording will stop automatically if no sound comes in for more than 30 seconds.

- If you want to adjust the recording level, see page 41.

When the digital signal comes in through the OPTICAL DIGITAL IN terminal, the unit does digital-to-digital recording.

- You cannot record the sound coming into this unit through the USB AUDIO terminal.

When you do not want to use Group recording function, press GROUP on the remote control to turn off the GROUP indicator on the display.



**1** Insert a recordable MD into the MD loading slot while the unit is turned on.

**2** Press USB/LINE repeatedly to select “LINE” or “DIGITAL IN.”

- Each time you press the button, the source changes as follows:



- If you have changed the source names, the changed names will appear.

**3** Press REC TIME on the remote control to select the recording length mode.

- Each time you press the button, the recording length mode changes as follows:

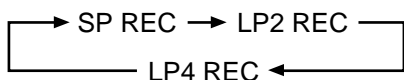

The indicator corresponding to the selected recording length mode lights up on the display.

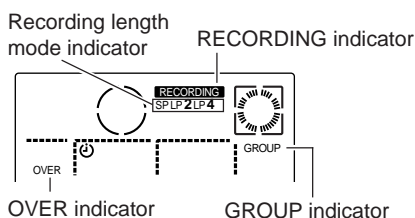

- For the recording length mode, see “Stereo Long-Hour Recording (MDLP)” on page 39.

**4** Press REC START on the unit.

“SOUND SYNC. START!” appears in the main display and the RECORDING indicator starts flashing, then “REC STANDBY” appears in the main display.

- If you want to start recording manually, simply press MD ►/II. In this case, Synchronized Recording is canceled.

**5** Start playback on the external equipment.

The RECORDING indicator remains lit up on the display and the recording starts.

To stop recording, press ■.

“WRITING” flashes for a while.

**To change the information shown in the main display while recording**

**On the remote control ONLY:**

Each time you press DISP/CHARA, the information in the main display changes as follows:

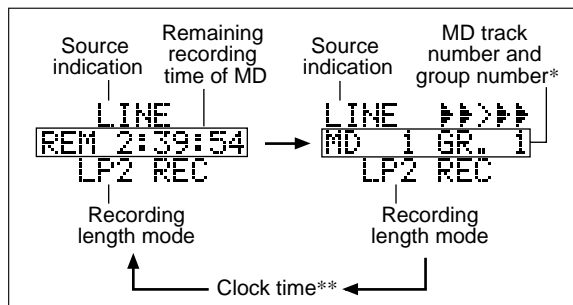

- \* When Group recording is activated.

- \*\* “0:00” flashes in the main display, before you set the built-in clock (see page 11).

**To put a track mark manually while recording**

**On the remote control ONLY:**

Press SET at the place where you want to put a track mark. “TRK MARKING” appears in the main display for a while.

- For details, see “About the track marks” on page 38.



**If you press REC START with USB selected as the source**

“CANNOT RECORDING!” appears in the main display.



**When recording from a DAT**

Two track marks may be recorded at the beginning of the recording. If this occurs, join these two track marks using the JOIN function described on page 57.



**About Sound Synchronized Recording**

Sound Synchronized Recording stops automatically if no sound comes into the unit for more than 30 seconds. In this case, the blank portion on the MD is about 2 seconds.

# Editing MDs

The buttons enlarged in the illustration below are used and explained in this section (pages 46 to 59).

**Remote control**

The diagram shows a JVC remote control with several buttons highlighted by callouts. On the left side, three callouts point to the 'MD TITLE /EDIT' button, a 'GROUP' button, and two 'GROUP' buttons with left and right arrow icons. On the right side, two callouts point to a vertical stack of three buttons labeled 'CANCEL', 'SET', and 'ENTER', which are also labeled with 'PTY SELECT +', 'PTY SELECT -', and 'RDS DISP.' respectively. Another callout on the right points to a horizontal stack of three buttons with left and right arrow icons.

**You cannot use the front panel to edit MDs.  
Use only buttons on the remote control.**

## Guidance—MD Group Functions

To add to the conventional MD Editing functions (called the track editing functions in this unit), MD Group functions help you to classify the tracks by making groups on your MD.

### Classifying the tracks on an MD

MDLP enables you to record more tracks on a single MD than usual. So, there are many tracks which have been recorded from the various sources—CDs, FM, and so on—on your MD.

In that case, if you can classify the tracks by source, by album, or by artist, the playback of your favorite songs becomes much easier.

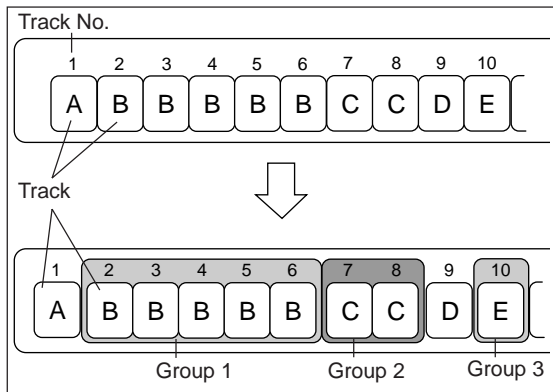

In the figure above, as an example, there are 5 different genres (from A to E) of tracks on the MD. Using MD Group functions, you can form a group by genre B tracks as Group 1.

By forming groups on the MD, you can classify the tracks by each genre—the album title, the artist, etc. You can also assign a name to each group (see page 61.)

### Using MD Group functions

MD Group functions consist of Group play, Group recording and Group editing.

- **Group play (see page 29):**

You can play back and repeat the desired group without making a program: For example, you can play back repeatedly the genre B tracks by selecting Group 1 in the left figure.

- **Group recording (see page 41):**

You can form a group while tracks are being recorded.

- **Group editing:**

You can edit the groups using the following functions:

- Forming a group (FORM GR)
- Adding a track to a group (ENTRY GR)
- Dividing a group (DIVIDE GR)
- Joining two groups (JOIN GR)
- Moving a group (MOVE GR)
- Ungrouping tracks (UNGROUP)
- Dissolving all groups (UNGR ALL)
- Erasing tracks in a group (ERASE GR)

### How to make up Groups

You can make up groups using two methods: Forming-a-group function and Group recording function.

- **Forming-a-group function—FORM GR:**

Select this when you want to make groups after recording.

- **Group recording function:**

Select this when you want to record and group tracks at the same time.



#### About information concerning MD Group functions

Once you edit an MD using MD Group functions, the MD is assigned some characters as the information concerning MD Group functions. These characters appear only when you play back the MD using the equipment incompatible with MD Group functions. If you edit the characters using such equipment, the groups on the MD will be dissolved.

## Introducing Group Editing Functions

The groups and tracks can be edited in many ways (Group editing functions and Track editing functions). From this page to page 54, the group editing functions are explained. For details on the track editing functions, see pages 55 to 59.

### Forming a group (FORM GR) : Page 48

This function forms a series of tracks or a single track in a new group.

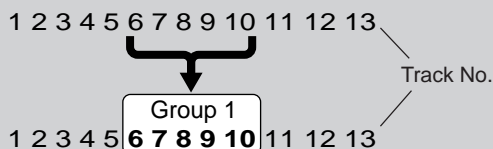

### Adding a track to a group (ENTRY GR) : Page 49

This function enters the selected track into a group.

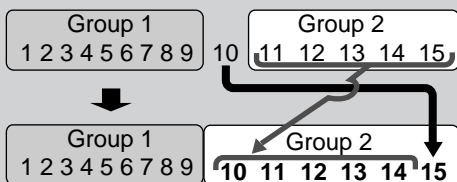

### Dividing a group (DIVIDE GR) : Page 50

This function divides a group containing plural tracks.

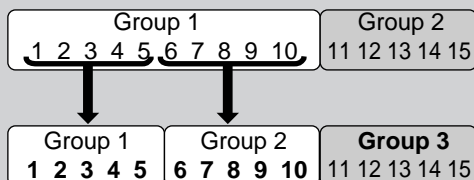

### Joining two groups (JOIN GR) : Page 51

This function joins two adjacent groups into a single group.

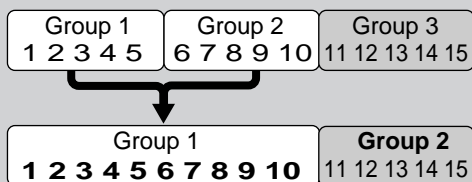

### Moving a group (MOVE GR) : Page 52

This function moves the selected group by reordering the group and track numbers.

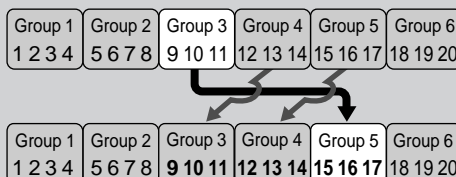

### Ungrouping tracks (UNGROUP) : Page 53

This function dissolves a group.

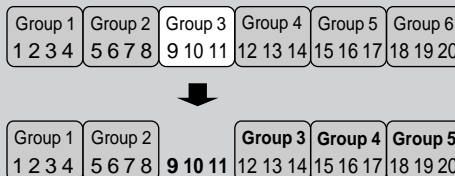

### Dissolving all groups (UNGR ALL) : Page 53

This function dissolves all the groups.

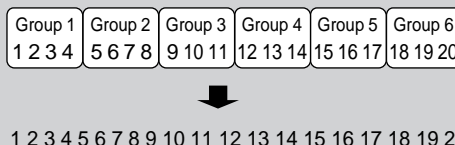

### Erasing a track in a group (ERASE GR) : Page 54

This function erases the tracks in the selected group.

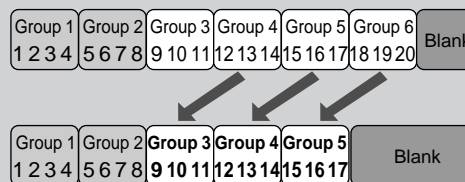

If "PLAYBACK DISC" or "DISC PROTECTED" appears when you try to edit an MD

You cannot edit such MDs. See pages 71 and 72.



During Program play or Random play mode

You can edit the MD as long as the unit is stopped. However, editing groups and/or tracks will resume Normal play mode (the program in memory will be cleared).

## Forming a Group—FORM GR

This function allows you to form a group from a series of tracks which do not belong to the other groups. You can form a group from a single track.

Once a new group is formed, the other groups are renumbered.

- You can form up to 99 groups on a single MD.
- To stop any time during the editing process after step 3, press MD TITLE/EDIT.

### On the remote control ONLY:

In the following example, the process is explained from the very first—that is, inserting a disc. You can also edit an MD during playback (in Normal play mode).

**1** Insert an MD you want to edit into the MD loading slot while the unit is turned on.

**2** Press MD TITLE/EDIT repeatedly until “FORM GR?” appears in the main display.

The main display shows the text "FORM GR?" in a large, pixelated font. Below it, in a smaller font, is "YES?→SET".

- If you want to stop this editing process, press ENTER.

**3** Press SET.

The main display shows the text "1?→" in a large, pixelated font. Below it, in a smaller font, is "OK?→SET".

- **During playback:**  
The current track number starts flashing.

**4** Press **▶▶/▶▶|** or **◀◀/◀◀** to select the first track from which a new group begins.

- You can select the track using number buttons. In this case, the selected track starts playback repeatedly.

The main display shows the text "3?→" in a large, pixelated font. Below it, in a smaller font, is "OK?→SET".

Ex. When track 3 is selected

- **During playback:**  
The selected track starts playback repeatedly.

**5** Press SET.

- If the selected track belongs to another group, “GROUP TRACK” appears in the main display. Select the track correctly in step 4 again.
- If you want to form a group from the selected track only, go to step 7.
- To cancel the setting, press CANCEL, then repeat step 4.

**6** Press **▶▶/▶▶|** or **◀◀/◀◀** to select the last track of the new group.

- You can select the track using number buttons. In this case, the selected track starts playback repeatedly.

The main display shows the text "3?→" in a large, pixelated font. To its right, "1??" is shown in a smaller font. Below both is "OK?→SET".

Ex. When track 12 is selected

- **During playback:**  
The selected track starts playback repeatedly.

**7** Press SET.

The main display shows the text "<FORM GR>" in a large, pixelated font. Below it, in a smaller font, is "YES?→ENTER".

- If the selected track belongs to another group, “GROUP TRACK” appears in the main display. Select the track correctly in step 6 again.
- To cancel the setting, press CANCEL, then repeat step 4.

**8** Press ENTER.

“EDITING” appears in the main display for a while, then “WRITING” flashes while the editing you have made is being recorded on the MD.

To dissolve the group again, see the UNGROUP function on page 53.



When “CANNOT FORM” appears in the main display

You are trying to form a new group which includes another group between the first track and the last one. In this case, dissolve the group and form a new one again.

## Adding a Track to a Group—ENTRY GR

This function allows you to enter a track into a group. The track will be added as the last track in the selected group. The track numbers will be renumbered.

- To stop any time during the editing process after step 3, press MD TITLE/EDIT.

### On the remote control ONLY:

In the following example, the process is explained from the very first—that is, inserting a disc. You can also edit an MD during playback (in Normal play mode).

**1** Insert an MD you want to edit into the MD loading slot while the unit is turned on.

- If the GROUP indicator is not lit on the display, press GROUP to activate this function.

**2** Press MD TITLE/EDIT repeatedly until “ENTRY GR?” appears in the main display.



ENTRY GR?  
YES?>SET

- If the loaded MD has no groups, “ENTRY GR?” will not appear.
- If you want to stop this editing process, press ENTER.

**3** Press SET.



TRK 1?  
OK?>SET

- **During playback:**  
The current track number starts flashing.

**4** Press >>>/>>> or <<</<<< to select the track.

- You can select the track using number buttons. In this case, the selected track starts playback repeatedly.



TRK 10?  
OK?>SET

Ex. When track 10 is selected

- **During playback:**  
The selected track starts playback repeatedly.

**5** Press SET.



GROUP --?

- When the selected track belongs to the group, its group number appears in the main display.
- To cancel the setting, press CANCEL, then repeat step 4.

**6** Press GROUP >>1 or 1<<< to select the group.



GROUP 2?  
OK?>SET

Ex. When group 2 is selected

- **During playback:**  
The tracks in the selected group are played back repeatedly.

**7** Press SET.



(ENTRY GR)  
YES?>ENTER

- To cancel the setting, press CANCEL, then repeat step 4.

**8** Press ENTER.

“EDITING” appears in the main display for a while, then “WRITING” flashes while the editing you have made is being recorded on the MD.



When “CANNOT ENTRY” appears in the main display

You are trying to enter a track in a group into the same group again. Repeat procedure from step 6.

## Dividing a Group—DIVIDE GR

This function allows you to divide one group into two separate groups.

You cannot divide the group containing a single track. When the original group has a title, two separate groups are reassigned the same title as the original group. Once a new group is divided, the other groups are renumbered.

- To stop any time during the editing process after step 3, press MD TITLE/EDIT.

### On the remote control ONLY:

In the following example, the process is explained from the very first—that is, inserting a disc. You can also edit an MD during playback (in Normal play mode).

#### 1 Insert an MD you want to edit into the MD loading slot while the unit is turned on.

- If the GROUP indicator is not lit on the display, press GROUP to activate this function.

#### 2 Press MD TITLE/EDIT repeatedly until “DIVIDE GR?” appears in the main display.

The main display shows the text "DIVIDE GR?" on the top line and "YES?->SET" on the bottom line. The "GR?" and "SET" are highlighted with a starburst effect.

- If the loaded MD has no groups, “DIVIDE GR?” will not appear.
- If you want to stop this editing process, press ENTER.

#### 3 Press SET.

The main display shows "GR 1" on the top line and "TRK 1" on the bottom line. Both "1"s are highlighted with a starburst effect.

- **During playback:**  
The current track number and its group number will appear. If the track does not belong to any groups, group number will be indicated by “- -.”

#### 4 Press GROUP >>| or |<< to select the group you want to divide.

The main display shows "GR 1" on the top line and "TRK 1" on the bottom line. Both "1"s are highlighted with a starburst effect.

Ex. When track 1 is selected

- **During playback:**  
The tracks in the selected group are played back repeatedly.

#### 5 Press >>>/>>| or |<<</<<< to select the track as the dividing point.

- You can select the track using number buttons. In this case, the selected track starts playback repeatedly.

The main display shows "GR 1" on the top line and "TRK 6" on the bottom line. The "6" is highlighted with a starburst effect. Below this, the text "TRK OK?->SET" is displayed.

Ex. When track 6 is selected

#### • During playback:

The selected track starts playback repeatedly.

- When “TRK OK?->SET” does not appear in the main display, you cannot go to the next step. Select another track.
- The track selected in this step will be the first track in the divided group.
- You cannot select the first track in a group as the dividing point.

#### 6 Press SET.

The main display shows "<DIVIDE GR>" on the top line and "YES?->ENTER" on the bottom line. The "YES?->ENTER" is highlighted with a starburst effect.

- To cancel the setting, press CANCEL, then repeat step 4.

#### 7 Press ENTER.

“EDITING” appears in the main display for a while, then “WRITING” flashes while the editing you have made is being recorded on the MD.

To join the divided groups again, see the JOIN GR function on page 51.

## Joining Two Groups—JOIN GR

This function allows you to join two adjacent groups into a single group.

When the groups have each title, the title of the preceding group is reassigned to the joined group.

Once two groups are joined, the other groups are renumbered.

- To stop any time during the editing process after step 3, press MD TITLE/EDIT.

### On the remote control ONLY:

In the following example, the process is explained from the very first—that is, inserting a disc. You can also edit an MD during playback (in Normal play mode).

- 1** Insert an MD you want to edit into the MD loading slot while the unit is turned on.

- If the GROUP indicator is not lit on the display, press GROUP to activate this function.

- 2** Press MD TITLE/EDIT repeatedly until “JOIN GR?” appears in the main display.



JOIN GR?  
YES?->SET

- If the loaded MD has one or no group, “JOIN GR?” will not appear.
- If you want to stop this editing process, press ENTER.

- 3** Press SET.



GR-->GR 1?

- **During playback:**  
The group number of the current track will appear. If the track does not belong to any groups, group number will be indicated by “--.”

- 4** Press GROUP >>1 or |<< to select the two adjacent groups you want to join.



GR 2+GR 3?  
OK?->SET

Ex. When the groups 2 and 3 are selected

- **During playback:**  
The tracks in the selected group are played back repeatedly.

- 5** Press SET.



<JOIN GR>  
YES?->ENTER

- To cancel the setting, press CANCEL, then repeat step 4.

- 6** Press ENTER.

“EDITING” appears in the main display for a while, then “WRITING” flashes while the editing you have made is being recorded on the MD.

To divide the group again, see the DIVIDE GR function on page 50.



When “CANNOT JOIN” appears in the main display

You are trying to join two groups with a track(s) in-between. In this case, you need to move the group or the track.



## Moving a Group—MOVE GR

This function allows you to move a group.

Once a group is moved, the tracks and the other groups are renumbered.

- To stop any time during the editing process after step 3, press MD TITLE/EDIT.

### On the remote control ONLY:

In the following example, the process is explained from the very first—that is, inserting a disc. You can also edit an MD during playback (in Normal play mode).

**1** Insert an MD you want to edit into the MD loading slot while the unit is turned on.

- If the GROUP indicator is not lit on the display, press GROUP to activate this function.

**2** Press MD TITLE/EDIT repeatedly until “MOVE GR?” appears in the main display.



- If the loaded MD has one or no group, “MOVE GR?” will not appear.
- If you want to stop this editing process, press ENTER.

**3** Press SET.



- During playback:**  
The group number of the current track will appear. If the track does not belong to any groups, group number will be indicated by “- -”.

**4** Press GROUP >>| or |<< to select the group you want to move.



Ex. When the group 3 is selected

- During playback:**  
The tracks in the selected group are played back repeatedly.

**5** Press SET.



- To cancel the setting, press CANCEL, then repeat step 4.

**6** Press GROUP >>| or |<< to select the position where you want to move the group.



Ex. When the group 6 is selected

- During playback:**  
The tracks in the selected group are played back repeatedly.
- To cancel the setting, press CANCEL, then repeat step 4.

**7** Press SET.



- To cancel the setting, press CANCEL, then repeat step 4.

**8** Press ENTER.

“EDITING” appears in the main display for a while, then “WRITING” flashes while the editing you have made is being recorded on the MD.

---

## Ungrouping Tracks—UNGROUP

---

This function allows you to dissolve a single group. You cannot erase the tracks using this function. Once tracks are ungrouped, the other groups are renumbered.

- To stop any time during the editing process after step 3, press MD TITLE/EDIT.

### **On the remote control ONLY:**

In the following example, the process is explained from the very first—that is, inserting a disc. You can also edit an MD during playback (in Normal play mode).

- 1** Insert an MD you want to edit into the MD loading slot while the unit is turned on.

- If the GROUP indicator is not lit on the display, press GROUP to activate this function.

- 2** Press MD TITLE/EDIT repeatedly until “UNGROUP?” appears in the main display.



UNGROUP?  
YES?->SET

- If the loaded MD has no group, “UNGROUP?” will not appear.
- If you want to stop this editing process, press ENTER.

- 3** Press SET.



GROUP 1?  
OK?->SET

- **During playback:**  
The group number of the current track will appear. If the track does not belong to any groups, group number will be indicated by “--.”

- 4** Press GROUP >>1 or 1<< to select the group you want to dissolve.



GROUP 3?  
OK?->SET

Ex. When the group 3 is selected

- **During playback:**  
The tracks in the selected group are played back repeatedly.

- 5** Press SET.



<UNGROUP>  
YES?->ENTER

- To cancel the setting, press CANCEL, then repeat step 4.

- 6** Press ENTER.

“EDITING” appears in the main display for a while, then “WRITING” flashes while the editing you have made is being recorded on the MD.

---

## Dissolving All Groups—UNGR ALL

---

This function allows you to dissolve all the groups. You cannot erase the tracks using this function.

- To stop any time during the editing process after step 3, press MD TITLE/EDIT.

### **On the remote control ONLY:**

In the following example, the process is explained from the very first—that is, inserting a disc. You can also edit an MD during playback (in Normal play mode).

- 1** Insert an MD you want to edit into the MD loading slot while the unit is turned on.

- If the GROUP indicator is not lit on the display, press GROUP to activate this function.

- 2** Press MD TITLE/EDIT repeatedly until “UNGR ALL?” appears in the main display.

```
UNGR ALL?
YES?+SET
```

- If the loaded MD has no group, “UNGR ALL?” will not appear.
- If you want to stop this editing process, press ENTER.

- 3** Press SET.

```
<UNGR ALL>
YES?+ENTER
```

- 4** Press ENTER.  
“EDITING” appears in the main display for a while, then “WRITING” flashes while the editing you have made is being recorded on the MD.

## Erasing Tracks in a Group—ERASE GR

This function allows you to erase a group together with tracks in the group.

You cannot resume the tracks in the erased group.

Once a group is erased, the other tracks and groups are renumbered.

- To stop any time during the editing process after step **3**, press MD TITLE/EDIT.

### On the remote control ONLY:

In the following example, the process is explained from the very first—that is, inserting a disc. You can also edit an MD during playback (in Normal play mode).

- 1** Insert an MD you want to edit into the MD loading slot while the unit is turned on.

- If the GROUP indicator is not lit on the display, press GROUP to activate this function.

- 2** Press MD TITLE/EDIT repeatedly until “ERASE GR?” appears in the main display.

```
ERASE GR?
YES?+SET
```

- If the loaded MD has no group, “ERASE GR?” will not appear.
- If you want to stop this editing process, press ENTER.

- 3** Press SET.

```
GR 1 ERASE?
ERASE?+SET
```

- **During playback:**  
The group number of the current track will appear. If the track does not belong to any groups, group number will be indicated by “- -.”

- 4** Press GROUP >>| or |<< to select the group you want to erase.

```
GR 3 ERASE?
ERASE?+SET
```

Ex. When the group 3 is selected

- **During playback:**  
The tracks in the selected group are played back repeatedly.

- 5** Press SET.

```
<ERASE GR>
YES?+ENTER
```

- To cancel the setting, press CANCEL, then repeat step **4**.

- 6** Press ENTER.

“EDITING” appears in the main display for a while, then “WRITING” flashes while the editing you have made is being recorded on the MD.

## Introducing Track Editing Functions

The groups and tracks can be edited in many ways (Group editing functions and Track editing functions). From this page to page 59, the track editing functions are explained. For details on the group editing functions, see pages 47 to 54.

### Dividing a track (DIVIDE) : Page 56

This function divides a track by adding a track mark(s) in the desired point(s) in the middle or where you want to search later.

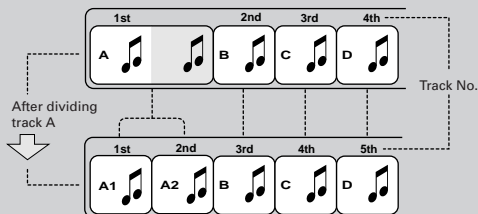

### Joining two tracks (JOIN) : Page 57

This function joins two adjacent tracks into a single track by deleting a track mark.

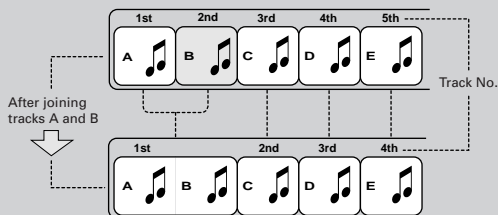

### Moving a track (MOVE) : Page 58

This function moves a track by reordering the track numbers.

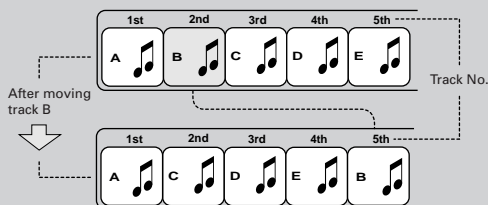

### Erasing tracks (ERASE) : Page 59

This function erases selected tracks. After the erasure, the subsequent tracks are justified and their track numbers are renumbered automatically. You can erase up to 15 tracks at a time.

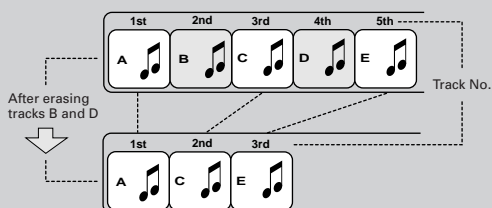

### Erasing all tracks (ALL ERASE) : Page 59

This function erases data in a disc entirely.

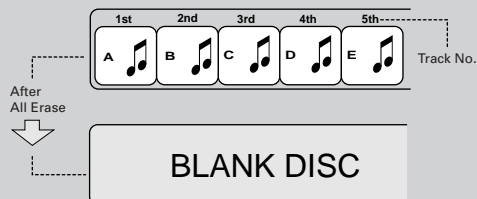

### Erasing a portion of a track

By combining "DIVIDE", "ERASE" and "JOIN", for example, it is possible to erase only a part of an existing track.

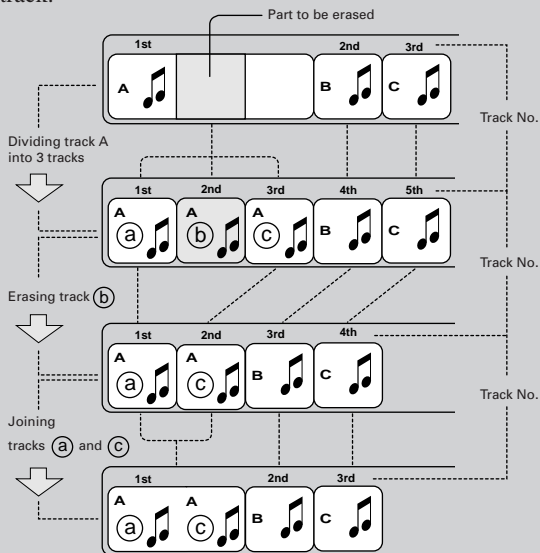

If "PLAYBACK DISC" or "DISC PROTECTED" appears when you try to edit an MD You cannot edit such MDs. See pages 71 and 72.



During Program play or Random play mode You can edit the MD as long as the unit is stopped. However, editing groups and/or tracks will resume Normal play mode (the program in memory will be cleared).

## Dividing a Track—DIVIDE

This function allows you to divide one track into two separate tracks. It is useful, for example, when you want to add track marks at a certain point within a track or if you want to separate a recording.

When the original track has a title, two separate tracks are reassigned the same title as the original track.

Once a new track is divided, the other tracks are renumbered.

- To stop any time during the editing process after step 3, press MD TITLE/EDIT.

### On the remote control ONLY:

In the following example, the process is explained from the very first—that is, inserting a disc. You can also edit an MD during playback (in Normal play mode).

- 1** Insert an MD you want to edit into the MD loading slot while the unit is turned on.

- If the GROUP indicator is lit on the display, press GROUP to turn off the GROUP indicator.

- 2** Press MD TITLE/EDIT repeatedly until “DIVIDE?” appears in the main display.

```
DIVIDE?
YES?→SET
```

- If the loaded MD has no or 254 tracks, “DIVIDE?” will not appear. (See “MD limitations” on page 70.)
- If you want to stop this editing process, press ENTER.

- 3** Press SET.  
The first track on the MD starts playback repeatedly.
- **During playback:**  
The current track number starts playback repeatedly.

- 4** Press ►►/►►| or |◄◄/◄◄ to select the track you want to divide.

- You can select the track using number buttons. In this case, the selected track starts playback repeatedly.

```
MD 3 GR. 1
0:04
TRK OK?→SET
```

Ex. When the track 3 is selected

- **During playback:**  
The selected track starts playback repeatedly.

- 5** Press SET when you find the point where you want to divide the track.

“POSIT.(position) 0” appears in the main display, and the unit repeats the selected point—a 3-second period following the dividing point.

```
POSIT. 0
OK?→SET
```

- If the dividing point is satisfactory, go to step 7. If not, go to the next step.
- To cancel the setting, press CANCEL, then repeat step 4.

- 6** Press ►►/►►| or |◄◄/◄◄ to precisely adjust the dividing point.

When you stop pressing the buttons, the unit repeats the newly selected dividing point.

- You can shift the dividing point up to  $\pm 128$ . This range ( $\pm 128$ ) corresponds to approximately  $\pm 8^*$  seconds (counted on the basis of SP mode) from the original point (Position 0).

```
POSIT. + 20
OK?→SET
```

Ex. When adjusting the point by +20

\* When “SP” is selected for the recording length mode. For “LP2,” it is approximately  $\pm 16$  seconds, and for “LP4” approximately  $\pm 32$  seconds.

- When you find the right position, go to the next step.
- To cancel the setting, press CANCEL, then repeat step 4.

- 7** Press SET.

```
<DIVIDE>
YES?→ENTER
```

- 8** Press ENTER.

“EDITING” appears in the main display for a while, then “WRITING” flashes while the editing you have made is being recorded on the MD.

To join the divided tracks again, see the JOIN function on page 57.

## Joining Two tracks—JOIN

This function allows you to join two adjacent tracks into one track.

When the tracks have each title, the title of the preceding track is reassigned to the joined track.

Once two tracks are joined, the other tracks and/or the groups are renumbered.

- To stop any time during the editing process after step 3, press MD TITLE/EDIT.

### On the remote control ONLY:

In the following example, the process is explained from the very first—that is, inserting a disc. You can also edit an MD during playback (in Normal play mode).

#### **1** Insert an MD you want to edit into the MD loading slot while the unit is turned on.

- If the GROUP indicator is lit on the display, press GROUP to turn off the GROUP indicator.

#### **2** Press MD TITLE/EDIT repeatedly until “JOIN?” appears in the main display.



JOIN?  
YES?+SET

- If the loaded MD has one or no track, “JOIN?” will not appear.
- If you want to stop this editing process, press ENTER.

#### **3** Press SET.

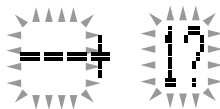

4 1?  
-->

- **During playback:**  
The current track number starts flashing.

#### **4** Press >>>/>>>| or |<<</<<< to select the two adjacent tracks you want to join.

- You can select the track using number buttons. In this case, the selected track starts playback repeatedly.



2 3?  
OK?+SET

Ex. When the tracks 2 and 3 are selected

- **During playback:**  
The selected track starts playback repeatedly.

#### **5** Press SET.



<JOIN>  
YES?+ENTER

- To cancel the setting, press CANCEL, then repeat step 4.

#### **6** Press ENTER.

“EDITING” appears in the main display for a while, then “WRITING” flashes while the editing you have made is being recorded on the MD.

**To divide the joined tracks,** see the DIVIDE function on page 56.



#### **If “CANNOT JOIN” appears in step 5**

You cannot join the following tracks.

- Tracks recorded using different recording length modes (SP, LP2, LP4). (See page 39.)
- Digital-recording tracks and analog-recording tracks.
- Tracks recorded using monaural long recording method (not possible on this unit) and stereo-recording tracks.



#### **When the tracks belongs to a group**

If the preceding track of two tracks you want to join belongs to a group, the newly joined track will belong to the same group; Otherwise, the joined track will not belong to any groups.

## Moving a Track—MOVE

This function allows you to move a track to the position you prefer. It is useful to change the order of the tracks as you like.

Once a track is moved, the tracks and/or the groups are renumbered.

- To stop any time during the editing process after step 3, press MD TITLE/EDIT.

### On the remote control ONLY:

In the following example, the process is explained from the very first—that is, inserting a disc. You can also edit an MD during playback (in Normal play mode).

- 1 Insert an MD you want to edit into the MD loading slot while the unit is turned on.

- If the GROUP indicator is lit on the display, press GROUP to turn off the GROUP indicator.

- 2 Press MD TITLE/EDIT repeatedly until “MOVE?” appears in the main display.



- If the loaded MD has one or no track, “MOVE?” will not appear.
- If you want to stop this editing process, press ENTER.

- 3 Press SET.

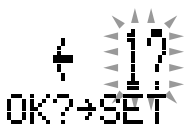

- **During playback:**  
The current track number starts flashing.

- 4 Press >>>/>>>| or |<<</<<< to select the track you want to move.

- You can select the track using number buttons. In this case, the selected track starts playback repeatedly.



Ex. When the track 2 is selected

- **During playback:**  
The selected track starts playback repeatedly.

- 5 Press SET.

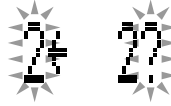

- To cancel the setting, press CANCEL, then repeat step 4.

- 6 Press >>>/>>>| or |<<</<<< to select the position where you want to move the track.

- You can select the track using number buttons. In this case, the selected track starts playback repeatedly.



Ex. When the track 5 is selected

- **During playback:**  
The selected track starts playback repeatedly.

- If the track selected in this step belongs to a group, the track selected in step 4 will be entered into the same group after moving.
- To cancel the setting, press CANCEL, then repeat step 4.

- 7 Press SET.



- To cancel the setting, press CANCEL, then repeat step 4.

- 8 Press ENTER.

“EDITING” appears in the main display for a while, then “WRITING” flashes while the editing you have made is being recorded on the MD.

## Erasing Tracks—ERASE

This function allows you to erase unwanted tracks. Once tracks are erased, the other tracks and/or groups are renumbered.

You can erase up to 15 tracks at a time.

- To stop any time during the editing process after step 3, press MD TITLE/EDIT.

### On the remote control ONLY:

In the following example, the process is explained from the very first—that is, inserting a disc. You can also edit an MD during playback (in Normal play mode).

- 1 Insert an MD you want to edit into the MD loading slot while the unit is turned on.

- If the GROUP indicator is lit on the display, press GROUP to turn off the GROUP indicator.

- 2 Press MD TITLE/EDIT repeatedly until “ERASE?” appears in the main display.



ERASE?  
YES?->SET

- If the loaded MD has no track, “ERASE?” will not appear.
- If you want to stop this editing process, press ENTER.

- 3 Press SET.



1 ERASE?  
ERASE?->SET

- **During playback:**  
The current track number starts flashing.

- 4 Press >>> or <<< to select the track you want to erase.

- You can select the track using number buttons. In this case, the selected track starts playback repeatedly.

- **During playback:**  
The selected track starts playback repeatedly.

- 5 Press SET.

“✓” appears in the main display.  
The track marked with “✓” will be erased.



✓ 2 ERASE?  
NO?->CANCEL

Ex. When the track 2 is selected

- When you do not want to erase the track, press CANCEL to remove “✓”

- 6 Repeat steps 4 and 5 to select all the tracks you want to erase.

- You can select up to 15 tracks.

- 7 Press ENTER.



<ERASE>  
YES?->ENTER

- 8 Press ENTER.

“EDITING” appears in the main display for a while, then “WRITING” flashes while the editing you have made is being recorded on the MD.

## Erasing All Tracks—ALL ERASE

This function allows you to erase all the tracks on an MD.

### On the remote control ONLY:

In the following example, the process is explained from the very first—that is, inserting a disc. You can also edit an MD during playback (in Normal play mode).

- 1 Insert an MD you want to edit into the MD loading slot while the unit is turned on.

- 2 Press MD TITLE/EDIT repeatedly until “ALL ERASE?” appears in the main display.



ALL ERASE?  
YES?->SET

- If the loaded MD has no track, “ALL ERASE?” will not appear.

- If you want to stop this editing process, press ENTER.

- 3 Press SET.



<ALL ERASE>  
YES?->ENTER

- To cancel the setting, press MD TITLE/EDIT.

- 4 Press ENTER.

“EDITING” appears in the main display for a while, then “WRITING” flashes while the editing you have made is being recorded on the MD.  
“BLANK DISC” and “NO TITLE” appear in the main display.



# Making Your Own Titles

The buttons enlarged in the illustration below are used and explained in this section (pages 61 to 63).

## Remote control

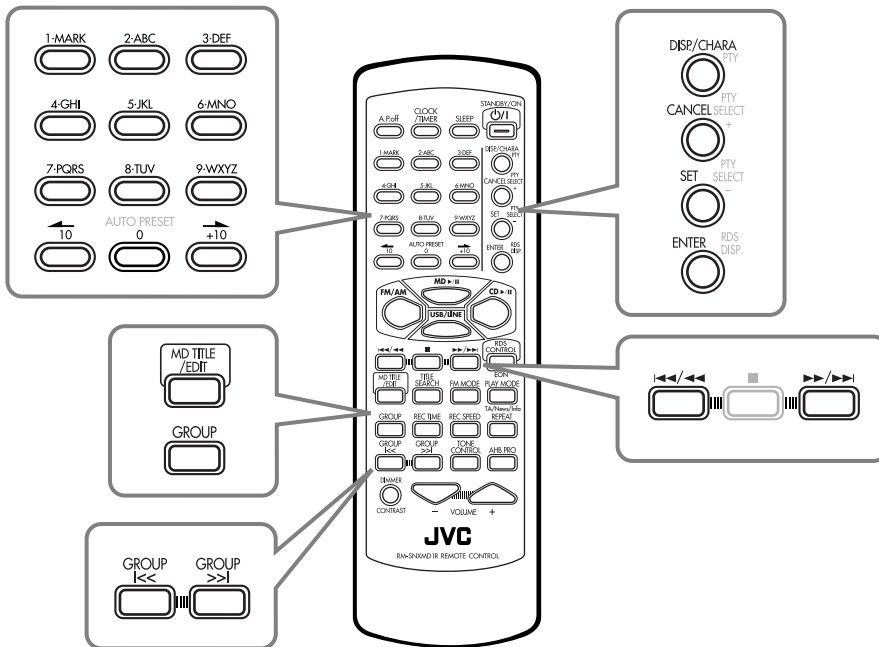

## Front panel

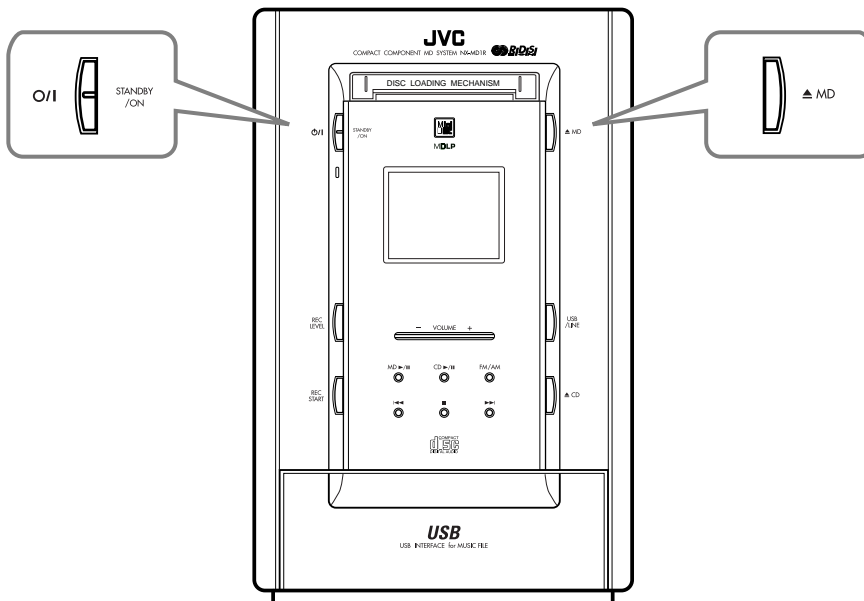

## Assigning Titles to an MD

You can assign a name to each MD, to each group and to each track using alphabetic characters (uppercase and lowercase), symbols and numerals. Once a title is assigned, it is displayed for your confirmation.

- You cannot edit titles composed of more than 61 characters.

In the following example, the process is explained from the very first—that is, inserting a disc. If you have already started recording or playing, start from step 2.

- When you want to assign a name to each group, press GROUP to turn on the GROUP indicator.**
- You cannot assign a name during playback in MD Program or MD Random play mode.
- To exit from the title entry screen any time during the process, press MD TITLE/EDIT.

**1** Insert an MD you want to edit into the MD loading slot while the unit is turned on.

**2** Enter into the title entry mode.

- For the disc title or the track title:**  
Press MD TITLE/EDIT.  
Disc title entry screen (while the total track number appears) or track title entry screen (during playback, pause, or recording) appears in the main display.

For the disc title



For the track 1 title



- For the group title:**  
Press MD TITLE/EDIT twice while the GROUP indicator is lit on the display.  
Group title entry screen appears in the main display.



- If you want to select the title entry screen again, press ENTER, then repeat this step.

**3** Select the desired title entry screen.

- For the disc title:**  
Press  $\lll$ / $\lll$  repeatedly until “DISC TITLE?” appears in the main display.
- For the track title:**  
Press  $\ggg$ / $\ggg$  or  $\lll$ / $\lll$  repeatedly until the desired track number and “TITLE?” appear in the main display.
- For the group title:**  
Press GROUP  $\ggg$  or  $\lll$  repeatedly until the desired group number (“GR” and the number) and “TITLE?” appear in the main display.

**4** Press SET.

The MD recorder enters one of the following title entry screens.

- Disc title entry screen:**

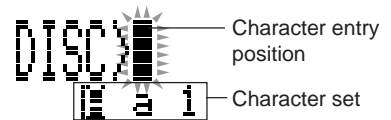

- Track title entry screen:**

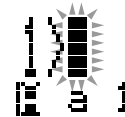

Ex. When the track 1 is selected

- Group title entry screen:**

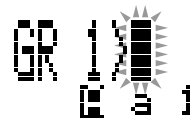

Ex. When the group 1 is selected

**5** Input character(s).

- Press DISP/CHARA to select the character set you want.

- Each time you press the button, the character sets change as follows:

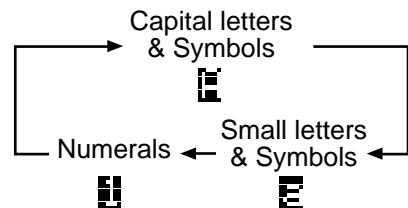

## 2) Press the character entry button for a character you want to input.

Examples:

- To input an "A" or "a," press ABC once.  
To input a "B" or "b," press ABC twice.  
To input a "C" or "c," press ABC three times.
- To input a symbol, press MARK repeatedly until the mark you want appears.
- To input a numeral, press 0 – 9.
- To enter a space while entering a title, press  $\rightarrow$  twice.
- To move the character entry position while entering a title, press  $\rightarrow$  or  $\leftarrow$ .
- If you have entered an incorrect character, press CANCEL to cancel the last entry.

## 3) Repeat steps 5 – 1) and 5 – 2) to input other characters.

- If the character you want to input next is assigned to the same button you have just pressed in step 5 – 2), press  $\rightarrow$  first to move the character entry position to the right.
- The main display can only show 6 characters at a time. If you enter the 7th character, the first character disappears, and so on.

## 6 Press ENTER.

The next title entry screen appears.

### • **For the disc title:**

The track title entry screen for the track 1 appears.

### • **For the track title:**

The next track title entry screen appears or the same screen still remains.

### • **For the group title:**

The next group title entry screen appears or the same screen still remains.

If you want to go on assigning a name, repeat steps 3 to 6.

## 7 Press ENTER to exit from the title entry mode.

- When recording, do not go to the next step until the recording ends.

## 8 Press $\blacktriangle$ MD on the unit to eject the MD.

"WRITING" flashes while the editing you have made is being recorded on the MD.

- If you press STANDBY/ON  $\odot$ /I instead of  $\blacktriangle$  MD, "WRITING" will flash while the editing, then the unit will be turned off (on standby.)



Available Symbols are as follows:

(Blank)	!	"	#	\$	%	&	'	( )
*	+	,	-	.	/	:	;	< =
>	?	@	_	\				



You can assign titles during playback or recording

### • **During play:**

#### – **Entering a disc title**

The MD recorder repeats playback of all the tracks of the MD until you press ENTER in step 6. When you press ENTER, the MD recorder enters the track title entry mode.

#### – **Entering a track title**

The MD recorder repeats playback of the current track until you press ENTER in step 6. When you press ENTER, the next track will be played.

#### – **Entering a group title**

The MD recorder repeats playback of the tracks in the group until you press ENTER in step 6. When you press ENTER, the MD recorder enters the next group title entry mode.

### • **During recording:**

The MD recorder continues recording even after you press ENTER in step 6. (When assigning a disc title, the MD recorder enters the track title entry mode.) If you do not press ENTER before recording ends, the assigned title will be canceled.

### • **During CD Synchronized Recording (see page 42):**

You can assign the disc title, and 16 titles for the tracks one after another as recording goes on. The track titles you have entered are automatically assigned to the tracks recorded on the MD in sequential order. If you enter more titles than the tracks on the recorded CD, they are ignored.



When you unplug the AC power cord or if a power failure occurs before step 8

The editing you have made is not recorded on the MD.

---

## Changing Titles

---

You can make a correction or change the title.

**1** Insert an MD you want to edit into the MD loading slot while the unit is on.

**2** Enter into the title entry mode.

- **For the disc title or the track title:**  
Press MD TITLE/EDIT.
- **For the group title:**  
Press MD TITLE/EDIT twice while the GROUP indicator is lit on the display.  
Group title entry screen appears in the main display.

- If you want to select the title entry screen again, press ENTER, then repeat this step.

**3** Select the desired title entry screen.

- **For the disc title:**  
Press ◀◀/◀◀ repeatedly until “DISC TITLE?” appears in the main display.
- **For the track title:**  
Press ▶▶/▶▶ or ◀◀/◀◀ repeatedly until the desired track number and “TITLE?” appear in the main display.
- **For the group title:**  
Press GROUP >>| or |<< repeatedly until the desired group number (“GR” and the number) and “TITLE?” appear in the main display.

**4** Press SET.

The MD recorder enters one of the following title entry screens.

**5** Press → or ← to select the character you want to correct.

- Make sure that the character you want to change is flashing.

**6** Press CANCEL to delete the character you have selected in the above step.

**7** Input the correct character, referring to step 5 on pages 61 and 62.

**8** Repeat steps 5 to 7 of the current procedure to correct more characters.

**9** Press ENTER to finish correcting the title.

- If you want to correct another title, repeat from step 3 of the current procedure.
- If you want to finish the correction, go to the next step.

**10** Press ENTER again to exit from the title entry mode.

**11** Press ▲ MD on the unit to eject the MD.

“WRITING” flashes while the editing you have made is being recorded on the MD.

### To erase all the characters

Press CANCEL repeatedly in step 6 left to erase all the characters, then go to steps 9 to 11.



### About the number of characters inputted for an MD

The total number of characters that can be input for an MD is 1 792. The maximum number that can be input for each title is 61. (However, the actual number you can input may be slightly less than this maximum number due to the MD limitations—see page 70.)

- A space can be counted as one character.
- When the stereo long-hour recording (LP2 or LP4: see page 39) method is used for recording, the maximum number you can input for a track title is automatically reduced since “LP:” and four spaces are automatically added to the beginning of the track title. Consequently this reduces the total number of characters you can input for an MD.

Example: You can input up to 10 characters for each track if an MD is composed of 120 tracks recorded using the stereo long-hour recording method.

# Using the Timers

The buttons enlarged in the illustration below are used and explained in this section (pages 65 to 67).

## Remote control

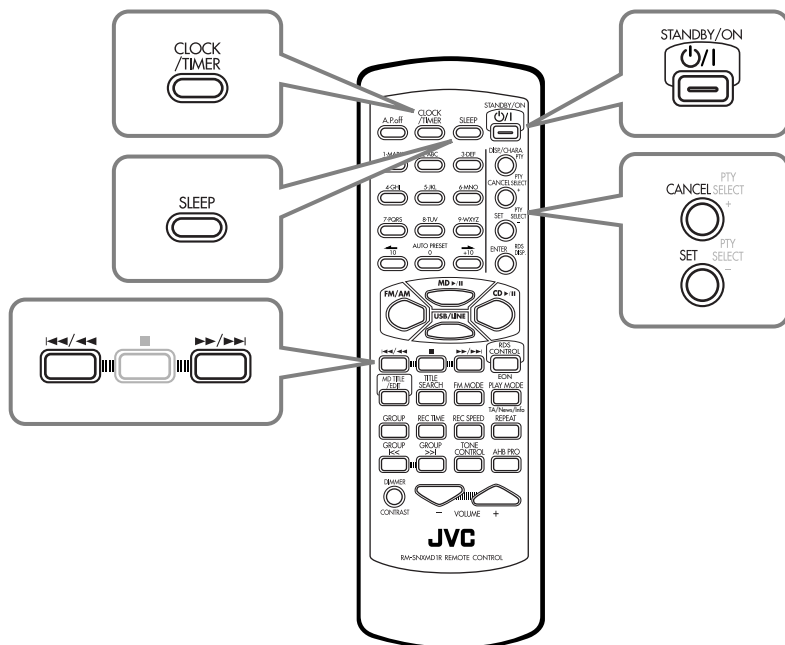

## Front panel

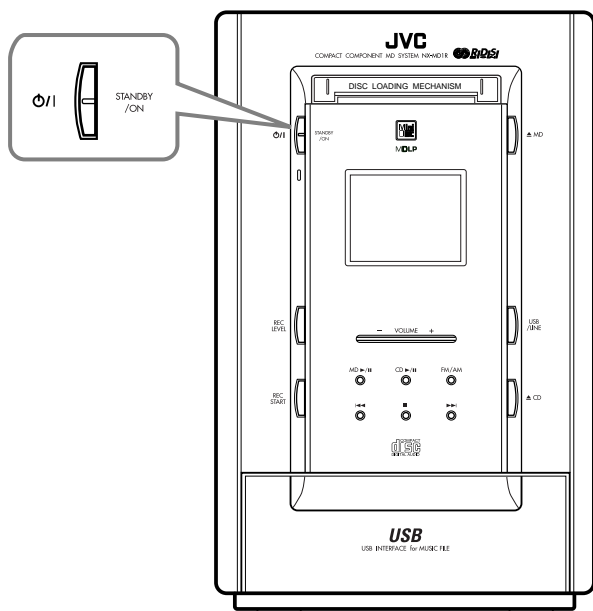

There are three timers available—Recording Timer, Daily Timer, and Sleep Timer.

**Before using these timers, you need to set the clock built in the unit (see page 11).**

## Using Recording Timer

With Recording Timer, you can make an unattended recording.

You can set Recording Timer whether the unit is turned on or in the standby mode.

- You need to load an recordable MD before starting this procedure.
- To correct a misentry any time during the setting process, press CANCEL.

### How Recording Timer actually works

The unit automatically turns on, muting the volume, and starts recording on the MD when the timer-on time comes.

Then, when the timer-off time comes, the unit automatically turns off (on standby).

Recording Timer works only once, but the timer settings remain stored in memory until you reset them or unplug the AC power cord.

#### On the remote control ONLY:

- 1 Press **CLOCK/TIMER** repeatedly until “**REC TIMER SET UP**” appears in the main display. The REC indicator starts flashing on the display. The hour digit of the timer-on time starts flashing.

```

REC TIMER
SET UP  →  ON
                OK?→SET
    
```

- 2 Set the timer-on time.

- 1) Press **▶▶/▶▶|** or **◀◀/◀◀** repeatedly to adjust the hour.
- 2) Press **SET**.  
The minute digit starts flashing.
- 3) Press **▶▶/▶▶|** or **◀◀/◀◀** repeatedly to adjust the minute.
- 4) Press **SET**.  
The hour digit of the timer-off time starts flashing.

- 3 Set the timer-off time by repeating the same procedure described in step 2.

- 4 Select the source to record from.

- 1) Press **▶▶/▶▶|** or **◀◀/◀◀** repeatedly to select the source.

The source changes as follows:

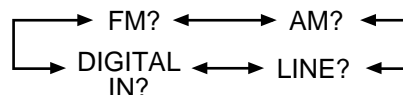

- If you have changed the source names, the changed names will appear in the main display.
- 2) Press **SET**.
    - When you select FM or AM (MW/LW) as the source, select a preset number by pressing **▶▶/▶▶|** or **◀◀/◀◀**, then press **SET**.
    - When you select LINE or DIGITAL IN as the source, prepare the external equipment with the timer function.

- 5 Select the recording length mode.

- 1) Press **▶▶/▶▶|** or **◀◀/◀◀** repeatedly to select the recording length mode (SP/LP2/LP4).

The recording length mode changes as follows:

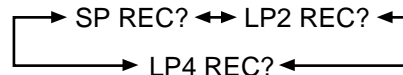

- 2) Press **SET**.  
The REC indicator stops flashing and remains lit on the display.  
The contents of this setting appear in the main display.

- 6 Press **STANDBY/ON** to turn off the unit if necessary.

**To turn off the Recording Timer after its setting is done**

- 1 Press **CLOCK/TIMER** once.
- 2 Press **CANCEL**.  
“REC TIMER OFF” appears in the main display, and the REC indicator goes off from the display.

**To turn on the Recording Timer**, press **SET**.

The REC indicator lights up on the display. The settings you have stored are shown in the main display for your confirmation.

- “NO SET SET REC!” appears in the main display before you enter the timer settings.



**Recording Timer will be canceled and the unit will not turn off automatically by operating the unit except when**

- Adjusting the volume
- Pressing AHB PRO
- Adjusting the Bass and Treble sounds

## Using Daily Timer

With Daily Timer, you can wake up to your favorite music or radio program.

You can set Daily Timer whether the unit is turned on or in standby mode.

- You need to load an MD or a CD before starting this procedure if you want to select it as the source.
- To correct a misentry any time during the setting process, press CANCEL.

### How Daily Timer actually works

The unit automatically turns on, and starts playing the specified source when the timer-on time comes. Then, when the timer-off time comes, the unit automatically turns off (on standby).

Daily Timer works every day, and the timer settings remain stored in memory until you reset them or unplug the AC power cord.

#### On the remote control ONLY:

- 1** Press **CLOCK/TIMER** repeatedly until “**DAILY TIMER SET UP**” appears in the main display. The DAILY indicator starts flashing on the display. The hour digit of the timer-on time starts flashing.

```

DAILY TIMER
SET UP → ON
OK?+SET
  
```

- 2** Set the timer-on time.

- 1) Press **▶▶/▶▶** or **◀◀/◀◀** repeatedly to adjust the hour.
- 2) Press **SET**.  
The minute digit starts flashing.
- 3) Press **▶▶/▶▶** or **◀◀/◀◀** repeatedly to adjust the minute.
- 4) Press **SET**.  
The hour digit of the timer-off time starts flashing.

- 3** Set the timer-off time by repeating the same procedure described in step 2.

- 4** Select the source to play back.

- 1) Press **▶▶/▶▶** or **◀◀/◀◀** repeatedly to select the source.  
The source changes as follows:

```

┌-----┐
└-----┘
┌-----┐
└-----┘
  
```

FM? ↔ AM? ↔ CD?  
DIGITAL IN? ↔ LINE? ↔ USB? ↔ MD?

- If you have changed the source names, the changed names will appear in the main display. (See page 36.)

- 2) Press **SET**.

- When you select “----” as the source, the unit starts playing the last selected source when the unit is turned off.
- When you select CD or MD as the source, select a track you want to start playback from by pressing **▶▶/▶▶** or **◀◀/◀◀**, then press **SET**.
- When you select FM or AM (MW/LW) as the source, select a preset number by pressing **▶▶/▶▶** or **◀◀/◀◀**, then press **SET**.
- When you select USB, LINE, or DIGITAL IN as the source, prepare an external equipment with the timer function.

- 5** Press **▶▶/▶▶** or **◀◀/◀◀** repeatedly to adjust the volume level, then press **SET**.

- You can adjust the volume level within the range of 0 (silent) to 50 (maximum).
- When you select “VOL. --,” the volume is set to the last volume level when the unit is turned off.

- 6** Press **▶▶/▶▶** or **◀◀/◀◀** to select “**FADE**” or “**NoFADE**”, then press **SET**.

- FADE** : Volume fades in (gradually becomes louder and is set to the specified level).
- NoFADE** : No fade-in effect. Volume is set to the specified level when the timer-on time comes.

The DAILY indicator stops flashing and remains lit on the display.

The contents of this setting appear in the main display.

- 7** Press **STANDBY/ON**  to turn off the unit.

#### To turn off the Daily Timer after its setting is done

- 1 Press **CLOCK/TIMER** three times.
- 2 Press **CANCEL**.

“DAILY TIMER OFF” appears in the main display, and the DAILY indicator goes off from the display.

#### To turn on the Daily Timer, press **SET**.

The DAILY indicator lights up on the display. The settings you have stored are shown in the main display for your confirmation.

- “NO SET SET DAILY!” appears in the main display before you enter the timer settings.



**When you select USB as the source**

Set the timer-on time to turn on the unit earlier than the PC.



**When you select CD or MD as the source**

You cannot play back in Program play mode, Random play mode or Repeat play mode.



**If the unit is kept turned on when the timer-on time comes**

Daily Timer does not work at all.



**Daily Timer will be canceled and the unit will not turn off automatically by operating the unit except when**

- Adjusting the volume
- Pressing AHB PRO
- Adjusting the Bass and Treble sounds

## Using Sleep Timer

With Sleep Timer, you can fall asleep to your favorite music.

You can set Sleep Timer when the unit is turned on.

### How Sleep Timer actually works

The unit automatically turns off after the specified time length passes.

#### On the remote control ONLY:

#### Press SLEEP.

The SLEEP indicator lights up on the display and the volume lamp on the front panel goes off.

“SLEEP” and sleep time appear in the main display.

SLEEP 10

- Each time you press the button, the time length changes as follows:

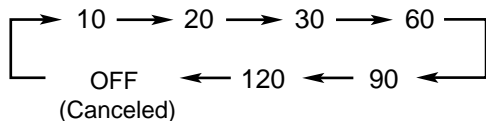

- The display dims when the sleep timer starts working.

**To check the remaining time until the shut-off time,** press SLEEP once. The remaining time until the shut-off time appears for about 5 seconds.

**To change the shut-off time,** press SLEEP repeatedly until the time length you want appears.

**To cancel the setting,** press SLEEP repeatedly until “SLEEP OFF” appears in the main display.



**Sleep Timer will be also canceled in the following cases:**

- When you turn off the unit.
- When you operate other timer settings.
- When you adjust the clock.

### To sleep with the Sleep Timer and wake up with the Daily Timer

The unit turns off when the shut-off time comes (set by the Sleep Timer), and turns on when the timer-on time (set by the Daily Timer) comes.

- 1 Set the Daily Timer as explained on page 66.
- 2 Start playing back any source you want to listen to before sleep.
- 3 Set the Sleep Timer.

## Timer Priority

Since each timer can be set separately, you may wonder what happens if the setting for these timers overlaps. Here are the priorities for each timer.

- **A timer with the later timer-on time has priority.**

If Recording Timer is set to come on while Daily Timer is operating, Daily Timer is canceled.

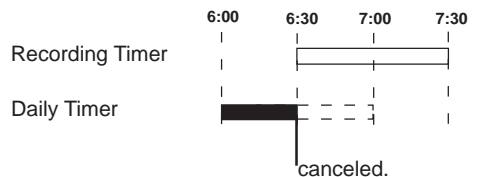

If Recording Timer is set to come on while Sleep Timer is operating, Sleep Timer will not turn off the unit even if the turn-off time comes.

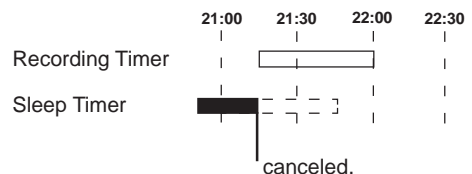



# Maintenance

To get the best performance of the unit, keep your discs and mechanism clean.

## General Notes

In general, you will have the best performance by keeping your CDs, MDs and the mechanism clean.

- Store CDs and MDs in their cases, and keep them in cabinets or on shelves.
- Keep the CD tray, and the MD loading slot cover closed when not in use.

## Handling CDs



- Remove the CD from its case by holding it at the edge while pressing the center hole lightly.
- Do not touch the shiny surface of the disc, or bend the CD.
- Put the CD back in its case after use to prevent warping.

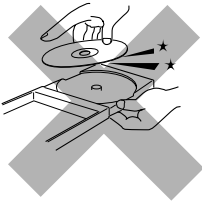

- Be careful not to scratch the surface of the CD when placing it back in its case.
- Avoid exposure to direct sunlight, temperature extremes, and moisture.



### To clean the CD

Wipe the CD with a soft cloth in a straight line from center to edge.



DO NOT use any solvent—such as conventional record cleaner, spray, thinner, or benzine—to clean the CD.

## Handling MDs

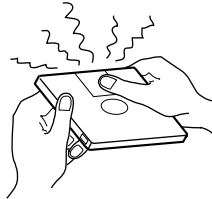

- Do not open the shutter.
  - The shutter is locked so that it will not open. Trying to force it open will break the MD. If the shutter opens accidentally, close it again quickly without touching the MD inside.

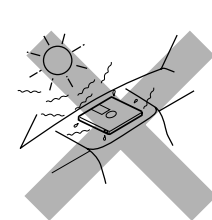

- Do not place MDs in the following places:
  - High temperature areas such as in direct sunlight or inside a car.
  - High humidity areas, e.g. in a bathroom.
  - On a beach or sandy area.

- Clean MDs regularly.
  - If dust or dirt gets on cartridge, wipe it off with a soft dry cloth.

## Cleaning the unit

### Stains on the unit

Should be wiped off with a soft cloth. If the unit is heavily stained, wipe it with a cloth soaked in water-diluted neutral detergent and wrung well, then wipe clean with a dry cloth.

- **Since the unit may deteriorate in quality, become damaged or get its paint peeled off, be careful about the followings.**
  - DO NOT wipe it with a hard cloth.
  - DO NOT wipe it strong.
  - DO NOT wipe it with thinner or benzine.
  - DO NOT apply any volatile substance such as insecticides to it.
  - DO NOT allow any rubber or plastic to remain in contact with it for a long time.

# Additional Information

## MD Disc Types

There are two types of MDs: Premastered (pre-recorded) and Recordable (blank).

### Premastered MDs

Premastered MDs, which have been recorded at music studio, can be played back like regular CDs. On an MD of this type, data is recorded as the presence or absence of tiny pits. A laser beam focuses on the pits on the surface of the MD and reflects the detection back to the lens in the MD recorder. The MD recorder then decodes the signals and plays them back as music. This type of MD is called an “optical disc.”

### Recordable MDs

Recordable MDs, which use magneto-optical technology, can be recorded and played back repeatedly. The laser inside the MD recorder applies heat to the MD, demagnetizing the magnetic layer of the MD for recording and playback. This type of MD is called an “magnetic-optical disc.”

## ATRAC (Adaptive Transform Acoustic Coding)/ATRAC3 (MDLP)

The MD provides 80 minute recording and playback time, much more than an audio CD, but in a diameter of only 64 mm. This ability to store such a large amount of data is the result of ATRAC, an audio compression technique developed for MD. This technology cuts out faint sounds that would not be heard by the human beings. This technology, based on human sensitivity to sounds, reduces recorded data volume up to about one-fifth of the original data volume.

Furthermore, this unit takes advantage of the latest ATRAC3 techniques, which can reduce the amount of data to record to one-tenth or one-twentieth of the original data volume. This allows for 2 times or 4 times long-hour stereo recording on this unit.

## UTOC (User Table Of Contents)

Found only on recordable MDs, this area contains sub-data (track number, recording data, etc.) which can be rewritten by the user.

UTOC enables us to search tracks quickly and edit tracks on the MD.

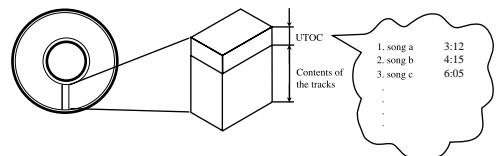

## Sound Skip Guard Memory

The biggest weakness of discs is their susceptibility to vibration. The “Sound Skip Guard Memory” has been developed to cope with this weakness.

With this function, a few seconds of signals read by the optical read head from the MD are first stored in memory before being reproduced as audio signals. Thus, even when vibration or shock interrupts signals being read, these stored signals can continue to reproduce sounds for the few seconds. Thus, the user will enjoy uninterrupted music.

Normally....

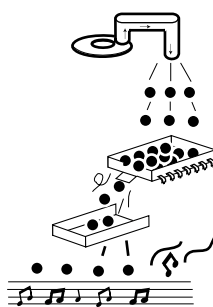

When “vibrated”....

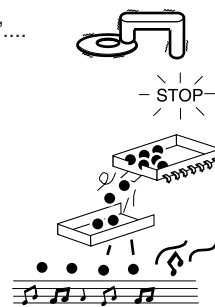

## SCMS (Serial Copy Management System)

The MD recorder integrated to this unit uses the Serial Copy Management System which allows only first-generation digital copies to be made of premastered software (like CDs or prerecorded MDs).

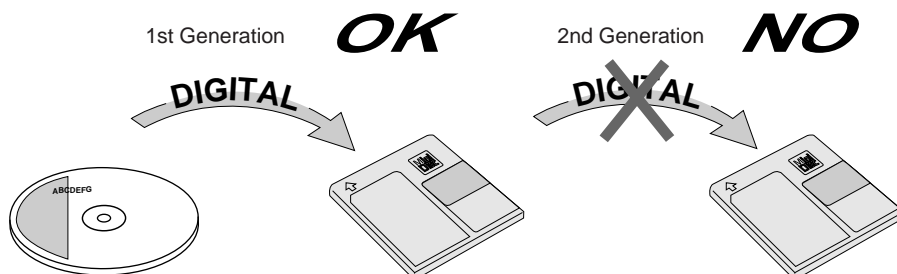

## HCMS (High-speed Copy Management System)

Now onto recordable MDs (minidiscs), you can record (copy) sound at a recording speed exceeding the normal speed. This fact requires some restrictions for protecting copyrights.

On this unit, you cannot re-record, at either high speed or normal speed, a song (track) that has been recorded once from a CD at high speed, until 74 minutes elapse after the first recording of the song started.

For example, after having recorded the first song (track) of a CD at high speed, you cannot record it again, at either high speed or normal speed, until 74 minutes elapse after the first recording of that song started.

### MD limitations

The MD records data in an original format that differs from that of conventional cassette tapes or DATs. Since there are some limitations with this recording format, the following types of symptoms may occur. These symptoms are not malfunctions.

Symptoms	Cause
"DISC FULL" appears, even though there is still enough remaining time on an MD.	There is a maximum number of tracks which can be recorded, regardless of recording time. More than 254 tracks cannot be recorded on an MD.
"DISC FULL" appears, even though the number of tracks and recording time do not reach the limit.	<ul style="list-style-type: none"> <li>Repeating erasure and recording on the same MD creates many blank portions sparsely on the MD. When recording on such an MD, a track is recorded on these blank portions sparsely. If a track is divided and recorded into so many portions, "MEMORY FULL" appears.</li> <li>If a divided portion of less than 8 seconds is made while a track is recorded on the MD, that track cannot be joined to another track using the JOIN function. Furthermore, if that track is erased, the remaining time of the MD may not increase exactly by the erased amount.</li> <li>If a track has been divided into many portions while being recorded on the MD, sounds will drop out while fast forwarding or reversing such an MD.</li> </ul>
The JOIN function sometimes does not work.	
The remaining time on the MD does not increase even when tracks are erased.	
The sound drops out during fast forward or fast reverse.	
The amount of recorded time on the MD added to the amount of remaining time is shorter than the MD's total possible recording time.	

# Messages

For MD:

Message	Signification	Solution
BLANK DISC	The disc is blank.	Change the MD with another if you want to enjoy playback.
CANNOT ENTRY	The track has already been in the selected group.	This is not a malfunction. (See “Adding a track to a group—ENTRY GR” on page 49.)
CANNOT FORM	You are trying to form a new group including other groups.	This is not a malfunction. (See “Forming a group—FORM GR” on page 48.)
CANNOT GROUP	There is no more space for storing information concerning MD group.	You cannot form a group any more on the MD.
CANNOT JOIN	You are trying to join tracks (shorter than 8 seconds) or groups which cannot be joined.	This is not a malfunction. (See pages 51, 57 and 70.)
CANNOT LISTEN!	You are trying to listen to the sound during high-speed recording.	This is not a malfunction. You cannot listen to the sound during high-speed recording.
CANNOT TITLE	You are trying to enter the title on the MD which already has over 1 792 characters in total.	This is not a malfunction. (See “Assigning Titles to an MD” on page 61.)
CD PROGRAM CANNOT x4 RECORDING!	You are trying to record a CD in program play mode using x4 speed-recording.	This is not a malfunction. Select other recording speeds. (See page 42.)
CD RANDOM CANNOT x4 RECORDING!	You are trying to record a CD in random play mode using x4 speed-recording.	This is not a malfunction. Select other recording speeds. (See page 42.)
DISC ERROR	There is a problem with the MD.	Change the MD.
DISC FULL	There is no more space on the MD or there are over 254 tracks.	Use another recordable MD or erase some tracks.
DISC PROTECTED	MD is write-protected.	Unprotect the MD or use another. (See page 38.)
EMERGENCY STOP	A malfunction has occurred during recording.	Stop playback, and eject the MD and re-insert it.
GROUP FULL	You are trying to form over 99 groups.	This is not a malfunction. There can be up to 99 groups on an MD
GROUP TRACK	You are trying to make a group of the track which belongs to another group.	This is not a malfunction. (See “Forming a group—FORM GR” on page 48.)
HCMS CANNOT COPY	You are trying to re-record a song that has been recorded once at high speed, before 74 minutes have passed after its first recording.	An internal timer works to protect copyrights. Wait for 74 minutes or more, then start recording.

Message	Signification	Solution
MD LOAD ERROR	MD is not loaded correctly.	Eject the MD and re-insert it.
MD NO DISC	There is no MD.	Put an MD.
NON-AUDIO CAN NOT COPY	You are trying to copy a non-audio disc like a CD-ROM, Video CD.	Stop recording.
PLAYBACK DISC	You are trying to edit or record on a playback-only MD.	Use a recordable MD.
SCMS CANNOT COPY	Digital copy of the 2nd generation is prohibited.	Use the external equipment connected to the LINE IN jacks (as the recording/playback device.)
x4 SPEED CANNOT COPY LOW TEMP	The room temperature is too low to record using x4-speed recording.	This is not a malfunction. You can record using x4-speed recording within 5°C – 35°C.

**For CD:**

Message	Signification	Solution
ALL SKIP TRK.	All the tracks on the CD have Track Skip mark.	Change the CD.
CANNOT PLAY	You are trying to play back a CD which cannot be played or there is a problem with the CD.	Change the CD.
CD LOAD ERROR	The CD tray does not open correctly because of the obstruction.	Press ▲ CD to close the CD tray, then remove the obstruction.
CD NO DISC	There is no CD.	Put a CD.
SKIP TRK.	The first track on the CD has Track Skip mark.	Wait for a while until the CD player finds the track without Track Skip mark.
UNFINALIZE	You are trying to play back a CD-R/RW which has not been “finalized.”	This is not a malfunction. You can play back “finalized” CD-R/RWs.

**For the others:**

Message	Signification	Solution
UNLOCK	There is no digital device connected to the OPTICAL DIGITAL IN terminal or no signal comes into the unit from the connected equipment.	Connect a digital device using digital optical cord (see page 8) or start playback the equipment.

# Troubleshooting

If you are having a problem with your unit, check this list for a possible solution before calling for service.

If you cannot solve the problem from the hints given here, or the unit has been physically damaged, call a qualified person, such as your dealer, for service.

Symptom	Possible Cause	Action
No sound is heard.	Connections are incorrect, or loose.	Check all connections and make corrections. (See pages 6 – 9.)
Unable to record on an MD.	<ul style="list-style-type: none"> <li>You are using a prerecorded MD.</li> <li>The MD is write-protected.</li> </ul>	<ul style="list-style-type: none"> <li>Change it with a recordable MD.</li> <li>Unprotect the MD. (See page 38.)</li> </ul>
Poor radio reception.	<ul style="list-style-type: none"> <li>The antenna is not connected correctly.</li> <li>The AM loop antenna is too close to the unit.</li> <li>The FM antenna is not properly extended and positioned.</li> </ul>	<ul style="list-style-type: none"> <li>Reconnect the antenna securely.</li> <li>Change the position and direction of the AM loop antenna.</li> <li>Extend FM antenna to the best reception position.</li> </ul>
Unable to operate the remote control.	<ul style="list-style-type: none"> <li>The path between the remote control and the remote sensor on the unit is blocked.</li> <li>The batteries have lost their charge.</li> <li>You are using the remote control far from the main unit.</li> </ul>	<ul style="list-style-type: none"> <li>Remove the obstruction.</li> <li>Replace the batteries. (See page 9.)</li> <li>Signals cannot reach the remote sensor. Move closer to the main unit.</li> </ul>
Loaded CD and MD cannot be ejected.	<ul style="list-style-type: none"> <li>The main AC power cord is not plugged in.</li> <li>The Disc Lock function is in use.</li> </ul>	<ul style="list-style-type: none"> <li>Plug in the AC power plug.</li> <li>Turn off the Disc Lock function. (See page 32.)</li> </ul>
The CD does not play.	The CD is upside down.	Put the CD in with the label side up.
The CD skips.	The CD is dirty or scratched.	Clean or replace the CD. (See page 68.)
If “ERROR” appears in the main display.	Something is wrong with your unit.	Unplug the unit immediately, then consult your dealer.
If “ERROR! SPK DC OUT” appears in the main display and no sounds come from the speaker.	The volume is too high.	Turn off the unit and unplug it, then consult your dealer.
Operations are disabled.	The built-in microprocessor has malfunctioned due to external electrical interference.	Press REC START and ▲ CD on the unit at the same time to reset the microprocessor, or unplug the unit then plug it back in.

# Specifications

## Amplifier

Output Power (IEC 268-3/DIN):

15 W per channel, min. RMS, both channels driven into 4  $\Omega$  at 1 kHz, with no more than 0.9% total harmonic distortion

Audio input sensitivity/Impedance (at 1 kHz)

Analog input:

LINE IN : 260 mV/56 k $\Omega$  (at "LEVEL 1")  
640 mV/56 k $\Omega$  (at "LEVEL 2")

Digital input:

OPTICAL DIGITAL IN : Optical  
Signal wave length: 660 nm  
Input level: -23 dBm to -15 dBm  
(With the built-in sampling rate converter, corresponding to 32 kHz/44.1 kHz/48 kHz)

USB AUDIO : Revision 1.0, Full-speed (with sampling frequency  
—32 kHz, 44.1 kHz, 48 kHz)

Audio output level/Impedance (at 1 kHz)

LINE OUT : 215 mV/3.9 k $\Omega$

Speakers/Impedance: 4  $\Omega$  – 16  $\Omega$

## Tuner

FM tuning range : 87.50 MHz — 108.00 MHz

AM (MW/LW) tuning range:

MW : 522 kHz — 1 629 kHz  
LW : 144 kHz — 288 kHz

## CD player

CD Capacity: 1 CD

Dynamic range: 88 dB

Signal-to-noise ratio: 95 dB

Wow and flutter: Immeasurable

## MD recorder

Audio playing system: MiniDisc digital audio system

Recording system: Magneto-optical overwrite system

Reading system: Non-contact, semiconductor laser pickup ( $\lambda=780$  nm)

Error correction system: CIRC (Cross Interleave Reed-Solomon Code)

Sampling frequency: 44.1 kHz  
(With sampling rate converter for recording—32 kHz/44.1 kHz/48 kHz)

Audio compression system:

ATRAC (Adaptive TRansform Acoustic Coding)/ATRAC3 (MDLP)

## General

Power requirement: AC 230V $\sim$ , 50 Hz

Power consumption: 60 W (at operation)

1.1 W (on standby: with display off)

1.3 W (on standby: with display on)

Dimensions (approx.):

150 mm x 237 mm x 274 mm (W/H/D)

Mass (approx.): 4.9 kg

## Supplied accessories

See page 6.

Design and specifications are subject to change without notice.

US and foreign patents licensed from Dolby Laboratories.

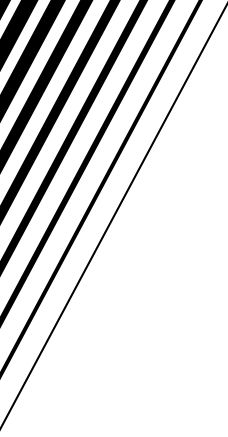

**JVC**  
VICTOR COMPANY OF JAPAN, LIMITED